

## **ITRO**

**A JOURNAL FOR INFORMATION TECHNOLOGY, EDUCATION DEVELOPMENT AND  
TEACHING METHODS OF TECHNICAL AND NATURAL SCIENCES**

Issue frequency

Once a year – electronic and paper issue

**Volume 7, December 2017.**

### **Publisher**

University of Novi Sad

Technical Faculty “Mihajlo Pupin” Zrenjanin

Department of Teaching Methods of Science and Education Technology

### **Chief and responsible editor**

Professor Dragana Glusac, Ph.D.

### **Program editor**

Professor Dijana Karuovic, Ph.D.

### **Editorial board**

Professor Dragica Radosav, Ph.D.

Professor Ivan Tasic, Ph.D.

Professor Marjana Pardanjac, Ph.D.

Docent Vesna Makitan, Ph.D.

### **Technical preparing of the Journal**

Dusanka Milanov, MSc

ISSN 2217-7949

### **Translator**

Erika Tobolka, Ph.D.

### Topic areas of the Journal

The Journal issues scientific, review and professional papers encompassing the following areas:

- teaching methods of subjects and educational technology in technical and natural sciences fields in pre-school education and training, elementary and high school, as well as colleges and faculties, and adults' training and education,
- pedagogy, didactics, psychology of learning, organizing of school work, methodology of pedagogical researches,
- papers of home sciences of single educational fields that is teaching subjects directed to bringing up to date the educational contents.

### Fields – sections in the Journal

- Information technologies in education development
- General topics important to any teaching methods
- Sections of any teaching methods where papers from natural and technical sciences teaching methods will be published
- Foreign experiences important for teaching methods development
- New issues – professional events of current interests
- Students' papers – special methodic topics

CIP – Katalogizacija u publikaciji  
Biblioteka Matice srpske, Novi Sad

004:371.3

**ITRO** [Elektronski izvor]: a journal for information technology, education development and teaching methods of technical and natural sciences / chief and responsible editor Dragana Glušac. – [Online izd.]-Elektronski časopis.- Vol. 1, no. 1 (dec. 2011) - . – Zrenjanin : Technical Faculty “Mihajlo Pupin”, Department of Teaching Methods of Science and Educational Technology, 2011 -

Dostupno i na <http://www.tfzr.uns.ac.rs/itro/journal.html>  
ISSN 2217-7949  
COBISS.SR – ID 268534279

## CONTENTS

Aleksandra ANĐELKOVIĆ <b>THE TEACHERS' AND STUDENTS' OPINIONS ABOUT FORMS AND DYNAMICS OF CONFLICTS OCCURRENCE IN ELEMENTARY SCHOOL.....</b>	<b>4</b>
Aleksandar STJEPANOVIĆ, Gordana JOTANOVIĆ, Mirko STOJČIĆ, Goran JAUŠEVAC, Đorđe STJEPANOVIĆ <b>COURSE MODULE FOR PURPOSE UPGRADING COMPETENCES OF STUDENTS ABOUT RENEWABLE ENERGY.....</b>	<b>12</b>
Gordana JOTANOVIĆ, Vladimir BRTKA, Goran JAUŠEVAC, Aleksandar STJEPANOVIĆ, Mirko STOJČIĆ <b>ASSESSMENT OF STUDENT ICT COMPETENCES IN COMPUTER SCIENCE COURSES.....</b>	<b>21</b>

# THE TEACHERS' AND STUDENTS' OPINIONS ABOUT FORMS AND DYNAMICS OF CONFLICTS OCCURRENCE IN ELEMENTARY SCHOOL

UDC 159.913:[371.12+371.212  
37:316.752  
Original research

**Aleksandra ANDELKOVIĆ\***

\*Teacher-Training Faculty in Vranje, Univeristy of Niš

Paper received: 25.05.2017.; Paper accepted: 13.06.2017.

**Abstract:** Conflicts are inevitable part of human relationships and thereby the relations at school. The author's research attention is focused on the analysis of conflict among teachers and students. The aims of research refers to the understanding assessments of teachers and students on conflict marks, and about their dynamics of occurrence. The total sample was made of 246 teachers and 280 students (N=526). Obtain result confirms that the conflicts between teachers and students are unwanted and that they are seen as negative. Conflicts are unlikely to be discussed from a personal angle, while conflicts happen more often to other students or other teachers and have more significant sources and forms of expression. The results also implicate that in area where the research was conducted, there is a need for programmes that are dedicated to recognizing and adequate resolving of conflicts in school.

## I. INTRODUCTION

Emphasizing the educational school function, the school practice, from many reasons, unjustified omits the improvement of quality relations among teachers and students, and caring of them. The conflicts among teachers and students are component of those relations. Theory of competency and competition (Deutsch, 1949), has changed the views on understanding the conflicts phenomen because until then Kurt Lewin claimed that common goals create interdependence of members in a group. Using the mentioned theory Morton Deutsch claimed that common goals can lead to different tensions. His theory of social interdependence highlights two conflict approaches cooperative and competitive, on which conflict outcomes are defined. Deutch emphasized that his theory cannot be the recipe book, that the practitioners will use in area of conflict solving. It represents the intellectual frame for understanding conflicts and methods of treatments in them (Deutsch, 2006, 31). Other authors (Gaffar, 2009; Hart & Guntz 1997; Johnson & Johnson, 1996 Tschannen-Moran, 2001,) confirmed that defining the conflicts depends on their dissolving. Tschannen-Moran (2001, 3) explain that a conflict management as a philosophy and a set of skills that assist individuals and groups in better understanding and dealing with conflict as it arises in all aspects of their lives. In the area in which shown research was conducted, the conflicts in schools, are the most common in the papers from psychology, and it confirms their the most dominant characteristics, psychologically origins (Golić & Vidović, 2004; Popadić, et al., 1996; 1998; Plut & Marinković 2001; Popadić, 2009; Vidović, & Galonja, 2005) while in recent times, authors who belong to pedagogical science appear (Anđelković, 2016) whereby they point out the significance and understanding of conflicts among teachers and students. The essence of this papers is in breaking stereotypes in school environment, that are according to the conflicts entirely negative phenomenon. Mentioned authors point out that conflicts and confrontations are not equal nor they can be experienced as

forms of violence and unacceptable behavior. It also shows that more intensive studying of conflict demonstrates that conflicts are natural and they bear constructive potential for social and personal development (Popadić et al. 1996). In school culture there are researches that confirm that conflict is not the same as violence; and the opinion, that children who are more aggressive make conflicts, is mislead and higher inclination and frequency of conflict with children is not an indicator of higher aggressivity (Popadić, 2009, 37,38); and the teachers are significant factor of influence that can reduce conflicts and change their course toward developing and improving their relations with students (Anđelković, 2016).

## II. THE CONFLICTS AMONG TEACHERS AND STUDENTS

There are conflicts in all organizations, so schools as learning organization are not excluded. The relations and the ways the conflicts are solved are indicators of relations development quality. Conflicts as a concept never remain positive or negative but they have always been seen as a basic and result oriented part of school life (Johnson & Johnson, 1996, 498). Conflict may originate from a number of sources, such as tasks, values, goals, and so on (Gaffar, 2009, 212), among individuals or groups. The schools as places that gather members of different generations, different interests and beliefs, frequently appear to be centers of tension. Actually, if the school is more traditional its openness and toward dialogue and conversation is lower because of the higher level of inequality of its participants. The authoritative relations in schools form significant misunderstanding and conflict relations. The conflicts are equal with verbal violence in schools (Popadić, 2007), they unfairly became processes that should be stopped and prevented.

Eventually the research focus is directed towards the programmes that successfully and on time resolve conflicts in schools. Many of those programmes are used for violence prevention in schools. Johnson and Johnson (1996, 498) hold that conflict resolution and peer mediation programs are often promoted as a way to reduce violence (and destructively managed conflicts) in schools. Programs reviewed show that social skills in the classroom can lead to increased academic performance. Prevention programs can improve academic performance, self-esteem, social skills, and employability skills. Effective programs should involve parents and community (Popović, 2012, 325). Teachers need further education about cooperative behavior in conflict situations, so they should be involved in lifelong learning programs that focus on building social skills in situations of conflict (Vlah, et al., 2015).

## III. METHODOLOGY OF RESEARCH

### *Goals and research variables*

The goal of this research is to determine assessments of teachers and students on conflict marks. Since conflicts are sometimes seen as exclusively negative instances, the research is an attempt of specifying them within the school context between teachers and students. Within the set goal several research tasks are set apart: 1) Determining the concept of conflicts between teachers and students and their frequency 2) Determining the frequency of personal conflicts and conflicts that other students and teachers have 3) Determining the connection of teachers' and students' assessments in accordance to control variables, teachers' degree and students' school success.

### *Sample of Research*

Research sample is appropriate and encompasses 246 teachers and 280 students of elementary schools in south Serbia, the Jablanica District. Control variables in the research were: teachers' degree and students' school success. From the total number of teachers 56.99 % were females, while 43.90% were males; with VI level of degree, were 44.71% and with VII level of degree were 55.28%. From the total number of students 48.6 % were females, while 51.490% are males; according to school success 45.7% students were with excellent success, 25.3% with very good success, 21.8% with good school success, 5.36% sufficient school success, and 1.8% with insufficient school success. The students were divided in two groups, the first category of better students was made of students with excellent and very good success while the second category called weaker students was made of students with good, sufficient and insufficient success.

### *Instrument and Procedures*

For researching several dimensions of conflict between teachers and students, the used questionnaire was created according to research needs (Spasić, 2008), in which one part of questions was oriented on analysis of teachers' and students' self-assessment of conflicts and dynamics of occurrence. Apart from calculations of percentages,  $\chi^2$  test was applied in order to analyze the statistical significance of differences.

### *Results of Research*

In order to understand the conflict between students and teachers the questioned had a possibility of choosing their own view on conflicts, the one which is closest to them. Participant of research had option of choosing, maximum two of the following possibilities: a) negative instance which should be stopped as soon as possible; b) situations which help students' development; c) possibility for a student and a teacher to express its own opinion; d) possibility for teacher and student to talk honestly; e) improvement of teacher and student relations; f) I have no precise opinion and g) possibility for self-definition. Teachers' and students' responses can be seen in Figure 1.1. and Figure 1.2.

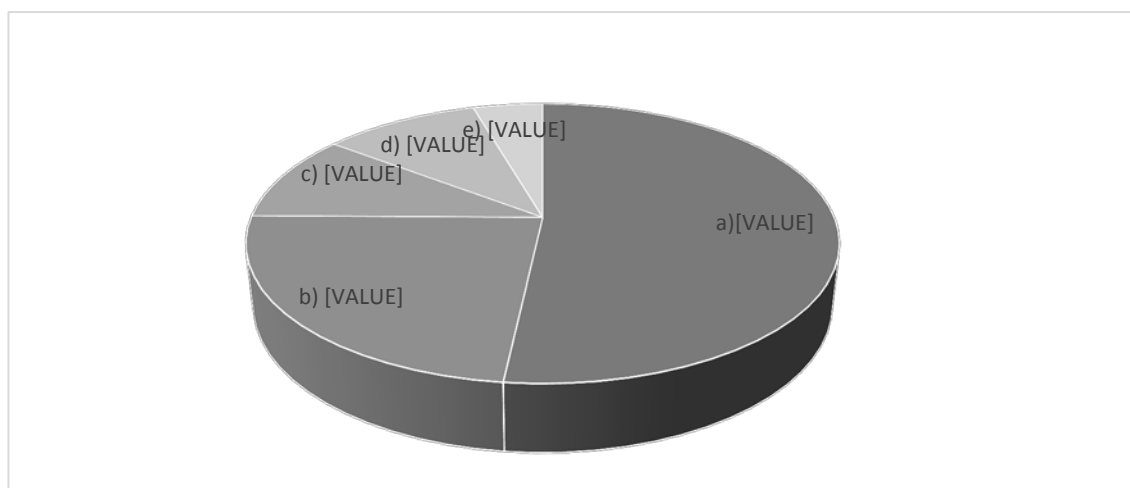

Figure 1.1. Review on teachers' assessment on conceptual understanding of conflicts

The offered possibilities of teachers' conflict understanding are classified in the following order: negative instance which should be stopped as soon as possible (46.98%), possibility for teacher and student to talk honestly (21.26%), possibility for a student and a teacher to express its own opinion (9.20%), improvement of teacher and student relations, I have no precise opinion (9.20%), and finally with a negligible percent: situations which help students' development (4.12%). Three questioned from the subsample of teachers have defined the conflict with students in the following manner: "not realizing the need of teachers and students", "real negative instance which is a reflection of the overall state in society", "excessive instance which ought to be changed by communication". The obtained value of  $\chi^2(5, N= 316) = 4.263, p > 0.05$ , do not exceed the limit values of significance level, it can be noted that teachers and students have similar assessments of conflicts. □<sub>2</sub>

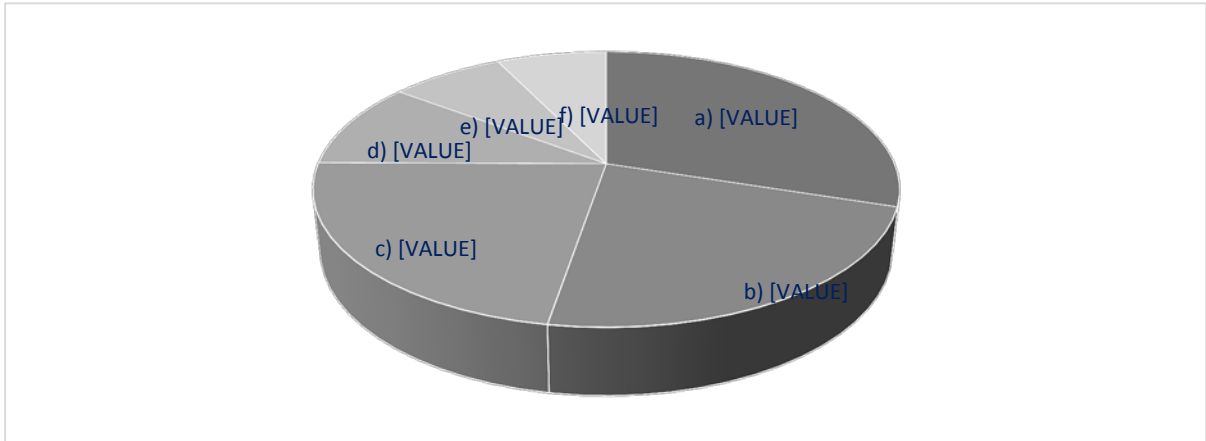

Figure 1.2. Review on students' assessment on conceptual understanding of conflicts

In the research sample, students have classified the offered options in the following order: a) negative instance which should be stopped as soon as possible (29.95%); b) possibility for teacher and student to talk honestly (22.70%); c) possibility for a student to express its own opinion (22.46%); d) I have no precise opinion (10.14%); e) situations which help students' development (7.48%); f) improvement of teacher and student relations (7.24%). Only one of all the students in the subsample has offered a qualitative view of conflicts with teachers, which is not optimistic: "situations in which a student never wins." This student has an excellent grade average. The obtained value of  $\chi^2(5, N=414) = 0.05$ , does not exceed the limit value of significance level, it can be confirmed that students with different school success have similar assessments of conflict with teachers. By comparing the responses of teachers and students it can be seen that the students unlike teachers have opted for the category: I have no precise opinion (10.14%). Of note is also that the teacher in a significant percent 46.98% of answers, when compared to students (29.95%) see conflicts as a negative instance which should be stopped as soon as possible. Although both subsamples the conflicts were seen as mostly negative by questioned, teachers assessment are quite higher than students. It was expected for the conflicts to be negatively valued, the fact that the students value nearly a half of responses as such, leaves a strong impression and opens numerous research questions, about the nature of communication in schools, about the relations between teacher and students and about student equality and the realization of the right to equality. The questions which stands out is whether our teacher possess the social and emotional competencies required for conflict resolution, apart from the expert ones which are necessary in this profession?

Are conflicts between students and teachers more frequent in certain parts of the school year? The intensity of work and workload can be a significant factor of their appearance. On Figure 2.1. and 2.2. are answers of teachers and students on frequency of conflicts in the period of more intensive grading.

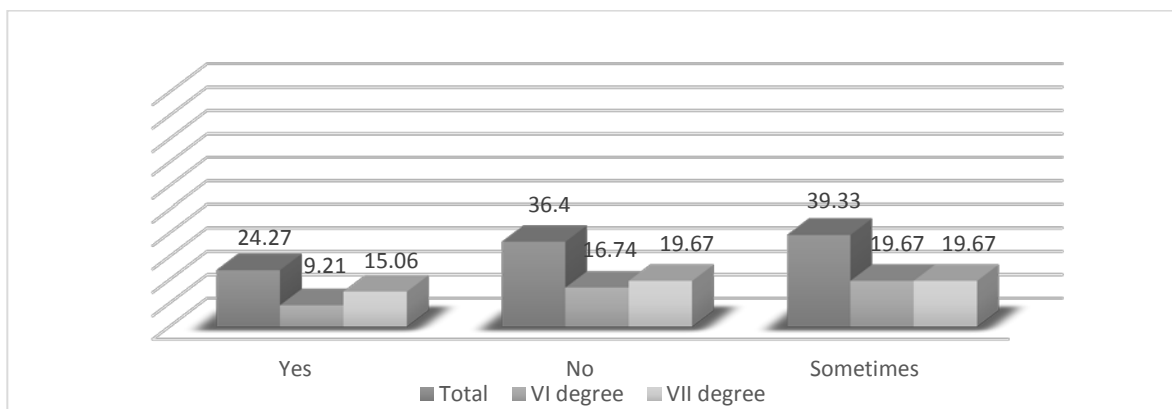

Figure 2.1. Review on teachers' assessment on frequency of conflicts in the period of more intensive grading

Most teachers have opted for the answer sometimes (39.33%), then the answer no (36.4%), while 24.27% have answered positively. However in student qualitative answers, as one of the biggest sources of conflicts with teachers, students have pointed out unreal evaluation. Periods of a more intensive grading are not seen as significantly more full of conflicts by teachers, it is assumed that these periods are less stressful for teachers. Furthermore, students' open type answers have pointed out that grades are used by teachers to punish indecent behaviour students and conflicts. The obtained value of 2.114),  $p > 0.05$  do not exceed the limit values of significance level, it can be noted that teachers of varying degrees have similar assessments of the frequency of conflicts in the periods of more intensive evaluation. □2 (2, N=239)

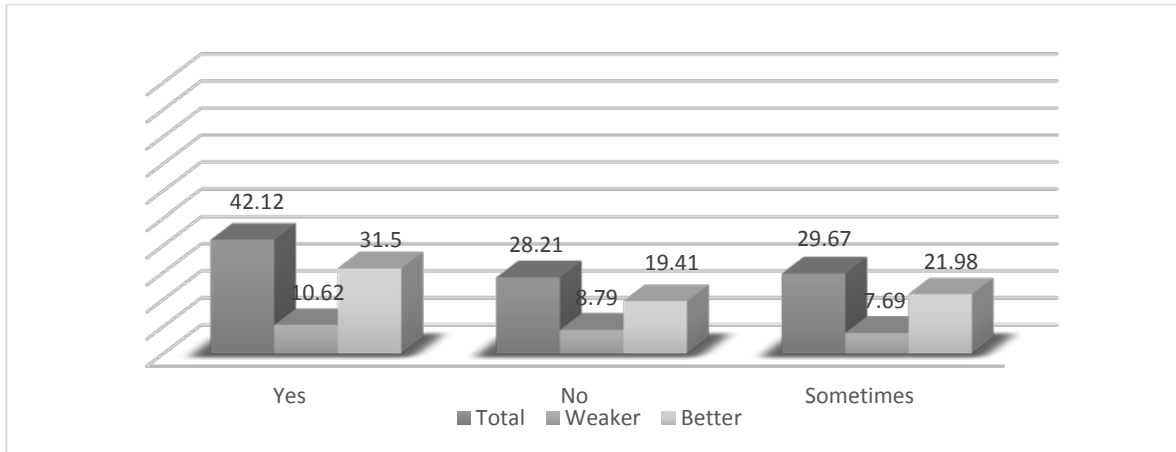

Figure 2.2. Review on students' assessment on frequency of conflicts in the period of more intensive grading

Students most often complain about the ways of grading and examination, which in their opinion are one of the most often sources of conflict with teachers, and this is not only seen in research results, so that responses on this kind of frequent conflicts was expected because there is a low percentage of those students, when compared to other possibilities, who think that the grading period is not conflictive (28.21%). During summarization of results it was noted that the students who have seen grading as the source of conflicts were primarily students with better grade average. This can be an indicator that for this category of students, when compared to those with lower grade average, the process of grading is more important and this is why they have more conflicts. The obtained value of 2.114),  $p > 0.05$  exceed the limit value of significance level, which confirms the similarities in the students' assessments with different school success on the frequency of conflicts at the period of more intensive grading. Teachers' and students' responses on personal conflicts are shown on Figure 3.1. and Figure 3.2. □2 (2, N = 273)

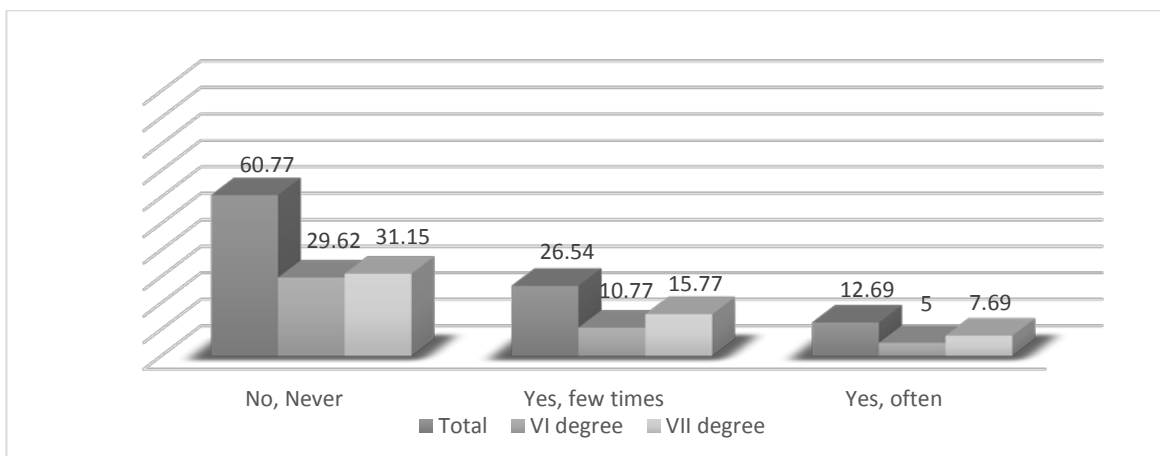

Figure 3.1. Review on teachers' assessment on personal conflicts



Regardless of their will or complaisance, conflicts with students, still happen. Conflicts are seen as unwanted, while 12.69 % teachers have responded to be quite often in conflict with students, 60.77 % claim that they have never been in conflict with students, while those who have experienced conflict sometimes is 26.54%. These results show teachers' opinions that conflicts with students do not happen to them, most likely because they do not see situations which are solved though cooperation or deal as conflicting. The obtained value of significance level, and there is no difference in assessments of the occurrence of personal conflicts between the respondents with varying degrees.

□2 (2, N=2

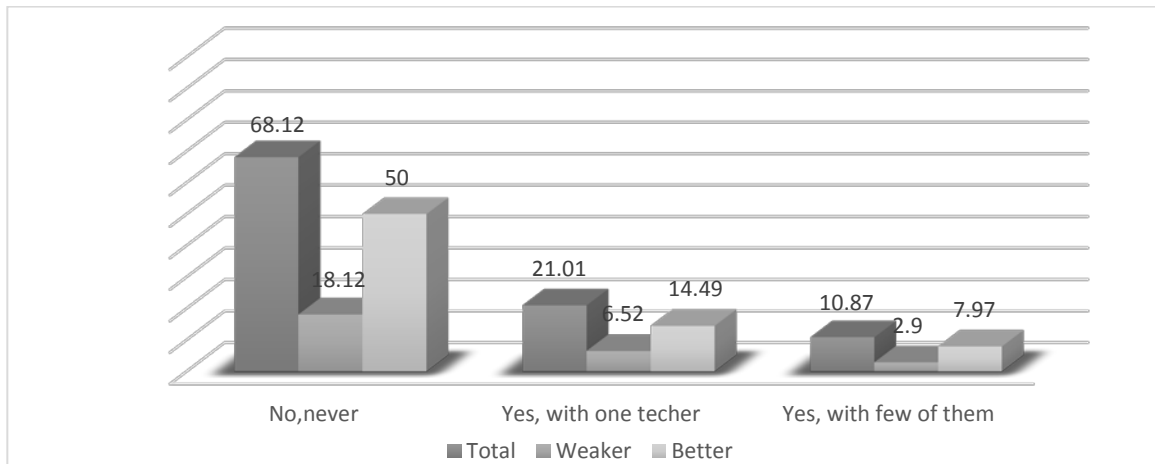

Figure 3.2. Review on students' assessment on personal conflicts

Most students in the sample (68.12%) declared that they have never been in conflict with teachers. A small number of students (21.01%) replied that they were in conflict with one teacher, while 10.87% replied they were in conflict with multiple teachers. The obtained value exceed the limit value for significance level, so that it can be confirmed that students of different school success, similarly assess the occurrence of personal conflicts with teachers.

□2 (2, N=2

Is it easier to talk about unacceptable and unwanted instances, which conflicts are for the participants of this research, if the same happen to other teachers and students? The responses of the questioned on conflicts of other teachers with students, and other students with teacher, are shown in Figure 4.1. and Figure 4.2.

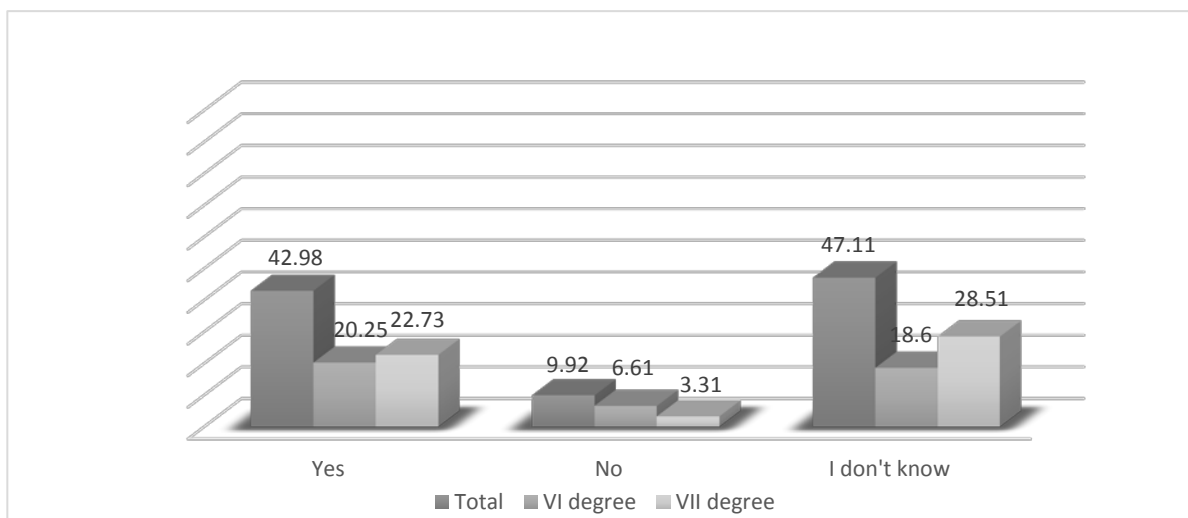

Figure 4.1. Review on teachers' assessment on conflicts with other teachers and students

When it comes to other teachers in school, conflicts happen significantly more often, in comparison to the questioned teachers, because only 9.92% of questioned teachers have strictly claimed that their

colleagues had no conflicts with students. This result may indicate that conflicts are unwanted in school environment or wrongly assessed, as something which should be hidden and something which is simpler to talk about when it happens to others. The obtained value of significance level, which confirms the statistically significant difference between teachers of different degrees about conflicts of other teachers with students.

□2 (2, N=242)

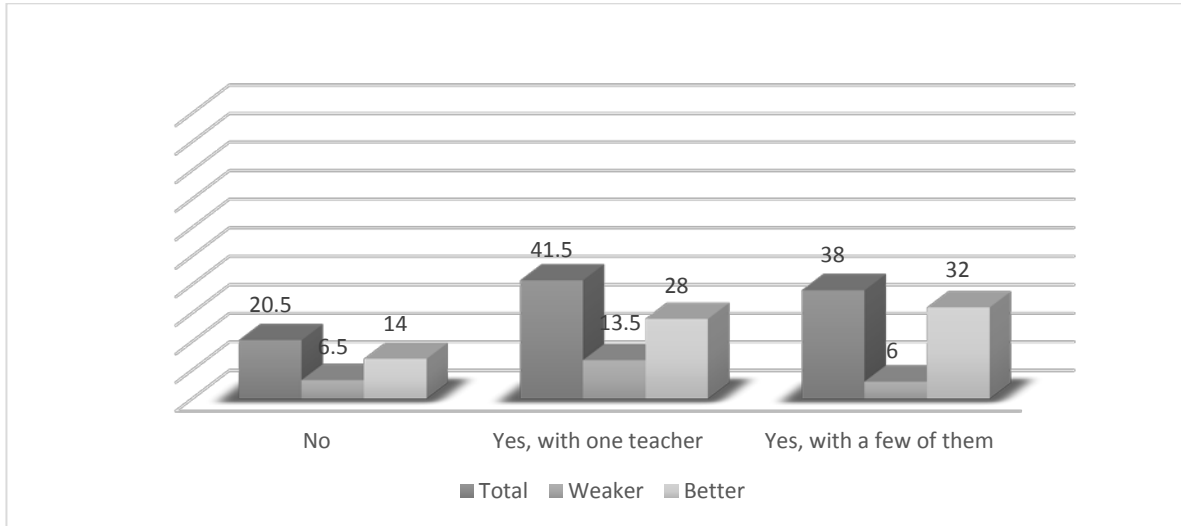

Figure 4.2. Review on students' assessment on conflicts with other teachers and students

Students think that conflicts with teachers happen more often to other students, in comparison to them. Based on students' responses it can be noticed that the percentage of students who have been in conflicts with one teacher (41.5%) is almost the same as the percentage of students (38%) who have been in conflict with multiple teachers. Conflicts are for the questioned teachers and students an instance which happens to others more often than to them. The obtained significance level, which confirms statistically significant differences in assessment between students of different school success on the frequency of conflicts of other students with teachers.

□2 (2, N=280)

#### IV. DISCUSSION AND CONCLUSIONS

Based on the given assessments of teachers and students on conflicts, certain conclusions can be made. It is a fact that students and teachers understand and experience conflicts differently. Conflicts and how they are seen in the conducted research cannot be assessed as the agents of influence on the sphere of development of their relationship. Mechanisms of repression and neglect of a conflict, are often teachers' tools for solving a conflict and settling relations with students. The act of grading is in itself a common source of conflict. Conflicts are unlikely to be discussed from a personal angle, while conflicts happen more often to other students or other teachers and have more significant sources and forms of expression. So latency becomes an important characteristic of conflict behaviour, and in the case of open conflict there is also a tendency towards concealment. The questioned teachers and students mostly see conflicts between teachers and students, (for teachers this percentage was almost 1/2 of questioned), as a negative instance which should be stopped immediately, which confirms that they are seen as anomalies in the relationship between teachers and students. The next most chosen category of answers, in both subsamples, is the possibility for the teacher and student to talk honestly, which confirms the existence of an impulse for a different understanding of conflicts, a way in which both sides are open to listen and understand each other. Also, it was confirmed that teacher sample sees conflicts as unpleasant situations when compared to students. Conflicts between teachers and students in the period of intensive grading are more common, especially for students who state that the grading process is one of the most basic and most common sources of conflict. Students' responses indicate that students with excellent grade average more than other categories of students see the grading period as more conflicting, so it can be assumed that this is due to the fact that they put more value on grades than students with lower grade average. Teachers agree that this period is of more conflicting nature, but in a lower percent than students.

As implication for school practice, a conclusion can be drawn that binding programmes for resolving conflicts that are intended for students and teachers can help breaking stereotypes about conflicts as occurrences that should be avoided or stopped by force. In support of this view, Hart and Guntz (1997) concluded that, in the last decade, an alternative form of response to this problem has been “conflict resolution and peer mediation” (CRPM) programs. Conflict management education is an important and effective strategy to make for positive change in school safety and climate (Tschannen-Moran, 2001), better educators and students understand the nature of conflict, the better able they are to manage conflicts constructively (Kinard, 1988). Including the higher education in development of this kind, Shahmohammadi (2014), highlights that the educational sciences and psychology faculties can be considered among the most important centers for offering this kind of training to schools. A limitations of research would be the use of students from elementary schools, whose judgement on conflicts is not yet mature. The pedagogical implication of further research are focused on examining conflicts between teachers and students in secondary schools.

#### REFERENCES

- [1] Anđelković, A. (2016): Saradnja i kreativnost nastavnika-alternative redukciji konflikata između nastavnika i učenika [Cooperation and creativity-alternatives for reduction of conflict between teachers and students]. *Godišnjak Učiteljskog fakulteta u Vranju*, br. 4, 197-209.
- [2] Deutsch, M. (1949). A theory of cooperation and competition. *Human Relations*, 2, 129–152.
- [3] Deutsch, M. (2006). Cooperation and competition. In: M. Deutsch, P. T. Coleman, & E. C. Marcus (Eds.), *The handbook of conflict resolution* (pp. 23–42). San Francisco, CA: Jossey Bass
- [4] Gaffar, A. (2009). Conflict in Schools: Its Causes and Management Strategies. *Journal of Managerial Sciences*; Vol. 3 Issue 2, 212-227.
- [5] Golić, M., Vidović, S. (2004): Preuzmi sudbinu u svoje ruke [Take the destiny into your own hands] Beograd: GTC.
- [6] Hanson, E.M. (1991). *Educational Administration and Organizational Behavior*. Boston: Allyn and Bacon.
- [7] Hart, J., & Guntz, M. (1997). The impact of a peer mediation program on an elementary school environment. *Peace & Change*, 22 (1), 76- 91.
- [8] Johnson D. & Johnson, R. (1996), *Conflict Resolution and Peer Mediation Programs in Elementary and Secondary Schools: A Review of the Research*. *Review of Educational Research*, Vol. 66, No. 4, American Educational Research Association, 459-506.
- [9] Kinard, J. (1988). *Management*. Lexington, Toronto: D.C. Health and Company.
- [10] Lewin, K. (1935). *A dynamic theory of personality*. New York: McGraw-Hill.
- [11] Maccoby, M., & Scudder, T. (2011). Leading in the heat of conflict. Retrieved 15/11/2017 from <http://www.maccoby.com/PDFs/Leading%20in%20the%20Heat%20of%20Conflict%20T+D%20Dec%202011.pdf>
- [12] Plut, D., Marinković, Lj. (2001). Konflikti i šta sa njima? [Conflicts and what to do with them?] Beograd: Kreativni centar.
- [13] Popadić, D. (2009). *Nasilje u školi*. [Violence at School] Beograd: Institut za psihologiju & UNICEF.
- [14] Popadić, D., Kovač-Cerović T., Mrše, S., Pečujlić-Mastilović, S., Kijevčanin, S., Petrović, D., Bogdanović, M. (1998). *Pametniji ne popušta, Vodič kroz sukobe do sporazuma*. [The smarter does not give up, the Guide through the conflicts to the agreement]. Beograd: Grupa MOST i Centar za antiratnu akciju.
- [15] Popadić, D., Plut, D, Kovač- Cerović, T. (1996). *Socijalni konflikti karakteristike i način rešavanja*. [Social Conflicts Characteristics and Way of Solving]. Beograd: Grupa MOST.
- [16] Popović, D. (2012). *Sistemi pristup u saradnji porodice i vaspitno-obrazovnih ustanova*. [Systematic Approach to Cooperation of Family and Educational Institutions]. *Pedagogija*. 3. 318-328.
- [17] Shahmohammadi; N. (2014). Conflict Management among Secondary school Students. *Procedia - Social and Behavioral Sciences*. 159. 630 – 635.
- [18] Spasić, A. (2008). *Izvori i oblici ispoljavanja konfliktnih situacija između nastavnika i učenika*. [Sources and Forms of Manifestation of Conflict Situations between Teachers and Students] unpublished master's thesis, Beograd: Filozofski fakultet.
- [19] Tschannen-Moran, M. (2001) *The Effect of a State-Wide Conflict Management Initiative in Schools*. *American Secondary Education* 29 (3). 2-32.
- [20] Vidović, S, Galonja, A, (2005). *Izazovi konflikt*. [Challenges Conflict]. Beograd: GTC.
- [21] Vlah, N., Jancec, L., Čepić, R. (2015) *Teachers' attitudes towards behavior patterns in social conflicts in Primorsko-Goranska County in Croatia*. *CEPS Journal* 5, 125-140.

# COURSE MODULE FOR PURPOSE UPGRADING COMPETENCES OF STUDENTS ABOUT RENEWABLE ENERGY

UDC 004.738.5:37

378.6:656

Original research

**Aleksandar STJEPANOVIĆ\***, **Gordana JOTANOVIĆ\***, **Mirko STOJČIĆ\***, **Goran JAUŠEVAC\***,  
**Đorđe STJEPANOVIĆ\*\***

\*Faculty of Transport and Traffic Engineering, Dobož, Bosnia and Herzegovina

\*\* Faculty of Technical Sciences, Novi Sad, Serbia

Paper received: 18.08.2017.; Paper accepted: 26.09.2017.

**Abstract:** This paper presents a course module containing exercises based on simulation tools that can be used to efficiently educate on Faculty of Traffic and Transport Engineering department of Telecommunications and Post Traffic undergraduate students. Theoretical methods were used for training, followed by simulation methods for different software packages used in scientific research, along with the presentation of solar cell models and photovoltaic modules. The concept is to offer our undergraduate students the opportunity to deeply understand the electrical behavior of solar cells and photovoltaics by virtually experimenting with individual solar cells and photovoltaic arrays creating their necessary mathematical models in the popular platform of Matlab/Simulink, PSpice and software package PVsyst.

## I. INTRODUCTION

Consumption of electricity in the world is constantly increasing. It is projected that world electricity demand will reach 25 trillion kWh by 2020. Most of the electricity used or produced so far is obtained by combustion of fossil fuels or nuclear processes. Thermal power plants, nuclear power plants, are natural polluters of the environment.

The alternative sources (renewable sources) to which man is surrounded on a daily basis, on the other hand, are pure ecological sources. In addition to this feature, they have the property of renewable sources, which is a very important feature. One of these sources is the Sun's energy and the energy of the Sun's radiation.

Converting the energy of solar radiation into electricity and using this method of producing the necessary energy becomes an important condition for further development and the advancement of the planet [1]. As the cost of PV systems decreases, while the energy needs of the globe become larger, people are focused on renewable energy sources especially PV technology [1,2].

In the solar industry, there is an increasing demand for well-trained and experienced personnel which, due to the nature of the PV subject, must have an interdisciplinary background.

This is one of the reasons why students on Faculty of Traffic and Transport Engineering, department of Telecommunications and Post Traffic must start learning about solar energy and its applications during

their studies making, at the same time, full use of modern educational facilities such as visual tools, simulators, the Internet.

#### *Student ICT competencies in the field of renewable energy*

Studying the competence of students, as well as models of courses in the field of renewable energy, has long been engaged in the European Union. There are a significant number of professional and scientific publications, as well as national strategies in the field of renewable energy in educational courses.

Particular importance is given to students' competence and the national strategy for their upgrading. The intensive development of the information society points to the need for continuous improvement of educational processes that are oriented towards renewable energy [1-4].

European Commission created the strategy "Europe 2020", which was established five main objectives that include employment, research and development, climate change/energy, education, social inclusion (poverty reduction) [1]. The globalization of business processes and processes in education requires the education system to constantly upgrade student competence standards. Through education, students need to achieve appropriate competence standards in order to be competitive in the employment market. Experts from the field of ecological sources of energy are one of the ones that are required in the European employment market. For this reason, it is necessary to educate students in the field of renewable energy (solar energy). The curriculum obsolescence, and not the quality assessment of students' competencies in university education, prevents students from sufficient flexibility and efficiency in the employment market. The Europe 2020 strategy is one of the student-centered mobility initiatives. By enhancing the competences of students in the field of renewable energy and their compliance with European standards, students are given greater mobility. Courses in the field of energy efficiency affect the quality of the education system.

The important topic of the electrical behavior of solar cells and PV arrays, taught in a typical "photovoltaic" undergraduate course, can be delivered to the students by using the proposed simulation tools as the basis for more advanced topics of PV technology. Students have to comprehend the basic diode physics and also to understand the photocurrent generation due to absorbed photons. Theoretical methods were used for basic training, followed by simulation methods for different software packages used in scientific research, along with the presentation of solar cell models and photovoltaic modules [5].

The accent was given to different models of the photovoltaic module that was selected for the experiment with the adaptability of the given model and for other types of photovoltaic modules.

## II. BASIC OF SOLAR ENERGY

Consumption of electricity in the world is constantly increasing. Most of the electricity used or produced so far is obtained by combustion of fossil fuels or nuclear processes. It is known that the reserves of coal, oil and other fossil fuels are quantitatively limited [6].

All this raises questions about the need for greater involvement in the flows that are oriented to ecological sources of energy. One of these sources is the Sun's energy and the energy of the Sun's radiation.

Converting the energy of solar radiation into electricity and using this method of producing the necessary energy becomes an important condition for further development and the advancement of the planet.

The history of the development of solar cells has had different directions. Due to its price, popularity, widespread use, silicon has retained the dominant position as the material most of which produces solar cells. The second vision was developed through thin film technology using various types of semiconductor compounds. One of the newer routes is the use of organic materials for the production of solar cells.

Continuous experiments with different types of materials are carried out in order to achieve as much efficiency as possible with low production costs and a lower price for the end customer. Experiments are

carried out with different materials, and in recent times, nanotechnology in the production of solar cells has become increasingly important.

The process of converting solar energy into electricity through solar cells is a fairly simple process. However, the degree of usefulness of this process is quite small. Unlike some early solar cells that had a degree of usefulness of the order of 1%, today's silicon-based solar cells achieve a conversion efficiency of 20% [7-9].

Despite the great success in the development of solar cells and improving their efficiency, this type of electricity production is still expensive. The need for optimizing the process and achieving the best possible results while simultaneously reducing costs is a very important condition for the massive application of solar cells or photovoltaic modules in the process of electricity generation.

During the research, many problems related to the use and application of this type of energy conversion were observed. One of the problems is a low degree of usefulness or a low degree of exploitation of the received solar radiation on the Earth.

The mean value of the intensity of solar radiation outside the atmosphere (also known as the solar constant) is  $1353\text{W/m}^2$ . Due to the attenuation caused by the atmosphere, the maximum intensity of the Sun's solar radiation at the sea level is around  $1\text{ kW/m}^2$ , giving an average value over 24 hours from  $0.2\text{kW/m}^2$  [8].

The intensity of radiation varies depending on the region of the planet, the time of day, the influence of climate factors. The light we see on a daily basis is just one part of the total energy emitted by the Sun. Sunlight is a form of electromagnetic radiation, and visible light is part of the electromagnetic spectrum. The electromagnetic spectrum describes light as a wave of a certain wavelength [9].

Some of the very important characteristics of solar radiation that have an important impact on photovoltaic conversion are [10]:

- the strength of the Sun's radiation,
- the spectral content of the incident solar radiation,
- the angle by which the sun's rays fall into the photovoltaic module,
- the energy of the Sun during a year or a day on a certain surface.

Physical description of the properties of light requires a quantum-mechanical analysis of light to the smallest particles called photons. The photon is characterized by either a wavelength  $\lambda$  or energy denoted by  $E$ . The relationship between these sizes is given by the formula [9]:

$$E = \frac{h \cdot c}{\lambda} \quad (1)$$

where:  $h = 6.626 \cdot 10^{-34}$  Js, Planck constant,  $c = 2.999.250 \cdot 10^8$   $\text{ms}^{-1}$ , speed of light in the free space.

An important quantity for determining the number of electrons that will be generated, and thus participating in the generation of current through the solar cell, is the photon flux. The photon flux is defined as the number of photons per second per unit area [11]:

$$\phi = \frac{\text{Number - of - fotons}}{\text{sek} \cdot \text{m}^2} \quad (2)$$

This term does not give us information about the energy or wavelength of the photon so that the energy and wavelength of the light source must be specified. To calculate the density of photon power at a given wavelength, we use the following form [9]:

$$H \left[ \frac{\text{W}}{\text{m}^2} \right] = \phi \cdot \frac{h \cdot c}{\lambda} (\text{J}) = \phi \cdot \frac{1.24}{\lambda [\mu\text{m}]} \cdot q \quad (3)$$

where:  $H$  is the density of the radiation power.

The radiation spectrum as a function of the photon wavelength or photon energy, denoted by  $E_\lambda$ , is one of the very important characteristics of a light source. In analyzes of solar cells, flux photons as well as the spectral characteristic of radiation are often used for calculations [11]. The following pattern defines the spectral characteristic of radiation:

$$E_\lambda = q \cdot \phi \cdot \frac{1.24}{\lambda^2 [\mu m]} \left[ \frac{W}{m^2 \mu m} \right] \quad (4)$$

To calculate the density of the radiation power emitted from a light source, we must take into account all wavelengths of interest.

$$H = \int_0^\infty E_\lambda(\lambda) \cdot d\lambda = \sum_{i=0}^\infty E(\lambda) \cdot \Delta\lambda \quad (5)$$

where they are:  $H$  is the total radiation density emitted from a light source [ $W/m^2$ ],  $E_\lambda(\lambda)$  is the radiation spectrum [ $Wm^{-2}\mu m^{-1}$ ],  $d\lambda$ ,  $\Delta\lambda$  wavelength [ $\mu m$ ].

### III. BASIC PARAMETERS OF SOLAR CELL

Solar cell is an electronic element that transforms the sun's energy into an electric one on the principle of photovoltaic effect. By its structure, the solar cell represents a  $pn$  compound in which photons from the Sun's radiation are absorbed, and their energy is used to create electron-cavity pairs. The internal electric field that exists in the depleted area separates the pairs of carriers that are created inside or near the  $pn$  joint.

The main characteristic that graphically describes the operation of the solar cell is current-voltage. The voltage-current characteristic of the solar cell passes through three characteristic points in which the most important parameters of the solar cell are defined [11]:

1. Short circuit current  $I_{sc}$  - current flowing when the voltage at the terminals of the solar cell is equal to zero,
2. Open circuit voltage  $V_{oc}$  - the voltage present on the solar cell terminals in the open circuit mode (i.e. when  $I = 0$ ),
3. Point of peak power  $P_m$  - the point at which the solar cell gives the highest possible power. The maximum power  $P_m$  corresponds to the largest possible surface of the rectangle that can be entered in the  $I$ - $V$  characteristic. At the point of maximum power the current value is  $I_m$ , and the voltage  $V_m$ .

In addition to the output current and the voltage on the solar cell, the point of the maximum output power of a cell is important, the maximum power of the solar cell, the fill factor, the temperature dependence of the solar cell.

The solar cell gives the maximum power of  $P_{max}$  at the voltage  $V_m$  and current  $I_m$  ie.  $P_{max} = V_m I_m$ . Based on this expression, a factor of fill  $FF$  (fill factor) can be defined:

$$FF = \frac{V_m \cdot I_m}{V_{oc} \cdot I_{sc}} = \frac{P_{max}}{V_{oc} \cdot I_{sc}} \quad (6)$$

where:  $V_m$  is the voltage at the point of the maximum power of the solar cell, the  $I_m$ -current at the maximum power point of the solar cell, the  $V_{oc}$  - the voltage of the open circuit of the solar cell, the  $I_{sc}$  - short - circuit current of the solar cell.

This factor is always smaller than the unit. All of these data are most often given by the manufacturer measured at standard test conditions (STC).

The ideal solar cell fill factor is marked by the index "0". This factor  $FF_0$  can be calculated via the empirically derived expression [8]:

$$FF_0 = \frac{v_{oc} - \ln(v_{oc} - 0,72)}{v_{oc} - 1} \quad (7)$$

Under the index "0" means that it is the value of the  $FF$  factor for the ideal solar cell without the effects of resistance.

The parameter  $v_{oc}$  represents the normalized value of the open circuit voltage through the voltage of the thermal potential and is given with the form:

$$v_{oc} = \frac{V_{oc}}{V_T} \quad (8)$$

where  $V_T$  is the thermal potential,  $V_{oc}$  voltage of the open circuit of the solar cell.

The output power of the solar cell is the product of the output current and voltage delivered to the consumer. The value of the power at the short-circuit current point is equal to zero.

The maximum power of the solar cell is at a point called MPPT (maximum power point) and denotes the point where  $V = V_m$  and  $I = I_m$ . If the relation  $P_m = I_m V_m$  is derived and is equal to zero, it gets [8]:

$$\frac{dP}{dV} = 0 = I_{ph} - I_{01} \cdot \left( e^{\frac{V_m}{V_T}} - 1 \right) - \frac{V_m}{V_T} \cdot I_{01} \cdot e^{\frac{V_m}{V_T}} \quad (9)$$

At MPPT point:

$$I_m = I_{ph} - I_{01} \cdot \left( e^{\frac{V_m}{V_T}} - 1 \right) \quad (10)$$

$$V_m = V_{oc} - V_T \cdot \ln \left( 1 + \frac{V_m}{V_T} \right) \quad (11)$$

The preceding equation is a transcendental equation according to  $V_m$ . The following experimentally obtained models are used to solve the given equations:

$$V_m = V_{oc} - 3 \cdot V_T \quad (12)$$

$$V_m = V_{oc} - \left( \frac{1 + \ln \beta}{2 + \ln \beta} \right) \cdot V_T \cdot \ln \left( \frac{1 + \ln \beta}{\ln \beta} \right) \quad (13)$$

where is:

$$\beta = \frac{I_{sc}}{I_{01}} \quad (14)$$

For modelling of solar cells and for a more precise analysis, an expanded model of a solar cell is used, which takes into account the effects of  $R_s$ ,  $R_{sh}$  resistance and the effect of recombination in the depleted layer.

An extended solar cell model is given in Figure 1. [8]:

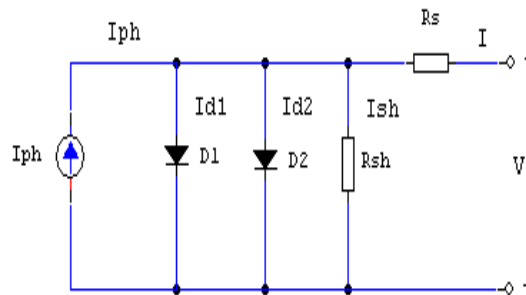

Figure 1. Expanded model of solar cell

The corresponding current-voltage characteristics of the solar cell can be defined:



$$I = I_{sc} - I_{01} \left[ e^{\frac{q(V+I \cdot R_s)}{k_B T}} - 1 \right] - I_{02} \left[ e^{\frac{q(V+I \cdot R_s)}{2k_B T}} - 1 \right] - \left( \frac{V + I \cdot R_s}{R_{sh}} \right) \quad (15)$$

By combining the diode (D1) and the diode (D2) and presenting a single diode, the following equation can be written:

$$I = I_{sc} - I_0 \left[ e^{\frac{q(V+I \cdot R_s)}{n \cdot k_B \cdot T}} - 1 \right] - \left[ \frac{V + I \cdot R_s}{R_{sh}} \right] \quad (16)$$

where:  $n$  is known as the diode ideality factor and ranges between 1 and 2.

The fig. 2. shows the simulation results for the previous solar cell model analyzed in the PSpice program package where the dependence of the output current and voltage on the solar cell (I-V curve) is shown.

The example is made for the solar cell used in the photovoltaic module type H250, the dimensions of the solar cell are 6.8cm x 6.8cm, the surface is 46.24cm<sup>2</sup>, with the current density  $J_{sc} = 34.3\text{mA/cm}^2$  and  $J_o = 10\text{-}11\text{A/cm}^2$ .

The simulation was done for several different lighting values ( $G = 200, 400, 600, 800, 1000\text{W/m}^2$ ).

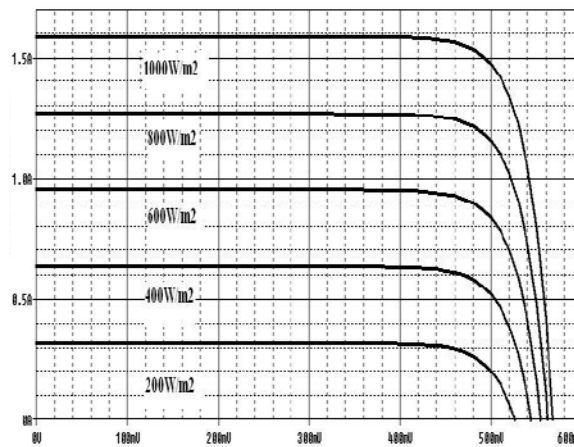

Figure 2. I-V curve of the solar cell, depending on the intensity of the illumination

#### IV. MATHEMATICAL MODEL OF PHOTOVOLTAIC MODULE

Solar cells are very rarely used alone. Cells of the same or similar characteristics mate in series or in parallel, then sealed in the housing and form photovoltaic solar modules. Each individual solar cell has an output voltage of about 600mV. These cells are connected in series to obtain the desired output voltage.

The standard number of serially connected cells is 36. The maximum current obtained by the cell at a radiation intensity of 100mW/cm<sup>2</sup> is approximately 30mA/cm<sup>2</sup>. In order to obtain the required output current, the solar cells are connected in parallel. Ideally, all cells in the module would have the same characteristics.

For the modeling of the complete module, the model from the solar cells shown in Figure 1. starts. The characteristics of the solar cell for the extended model are given to the pattern [8-11]:

$$I = I_L - I_0 \cdot \left( e^{\frac{V+I \cdot R_s}{n \cdot V_T}} - 1 \right) - I_{02} \cdot \left( e^{\frac{V+I \cdot R_s}{2 \cdot V_T}} - 1 \right) - \frac{V + I \cdot R_s}{R_{sh}} \quad (17)$$

For series-connected solar cells in the photovoltaic module, the current and voltage are calculated:

$$I_{scM} = I_{sc} \quad (18)$$

$$V_M = N_s \cdot V \quad (19)$$

$$V_{ocM} = N_s \cdot V_{oc} \quad (20)$$

where they are:  $N_s$  - number of solar cells connected to the series,  $I_{scM}$  - short-circuit current of the module,  $V_{ocM}$  - open circuit of the module,  $V_M$  - module output voltage,  $I_M$  - module output current,  $V_{oc}$  - voltage of the open circuit of the solar cell,  $I_{sc}$  - short - circuit current of the solar cell .

The total serial resistance of the module is:

$$R_s = N_s \cdot R_{s0} \quad (21)$$

In this case:  $R_{s0}$  is the serial resistance of an individual solar cell.

The current of the module is the same:

$$I_M = I_{scM} - I_{scM} \cdot \frac{\left( e^{\frac{V_M + I_M \cdot R_{sM}}{n \cdot V_T \cdot N_s}} - 1 \right)}{\left( e^{\frac{V_{ocM}}{n \cdot V_T \cdot N_s}} - 1 \right)} \quad (22)$$

With some neglect, it gets:

$$I_M = I_{scM} \cdot \left( 1 - e^{\frac{V_M + I_M \cdot R_{sM} - V_{ocM}}{n \cdot V_T \cdot N_s}} \right) \quad (23)$$

The serial resistance of the module is calculated from the form:

$$R_{sM} = \frac{V_{ocM}}{I_{scM}} - \frac{P_{\max M}}{FF_{0M} \cdot I_{scM}^2} \quad (24)$$

Using the equations the basic model of the photovoltaic module can be presented. The following fig. 3. shows the model.

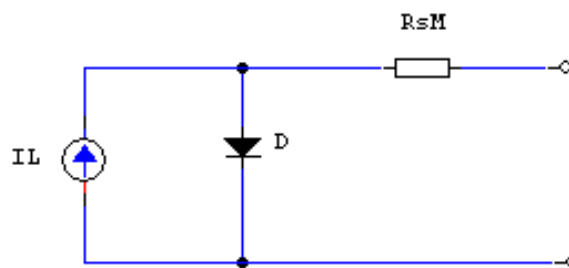

Figure 3. Model of solar module

For the analysis of the voltage-current and voltage-power characteristics, a 25W H250 photovoltaic module was used.

V. THE EXERCISES WITH DIFFERENT SOFTWARE TOOLS FOR UPGRADING COMPETENCES OF STUDENTS

A. *The first exercise*

During the theoretical classes, students are introduced to the basics of the PSpice of the software package and the possibilities of its application in the analysis of photovoltaic modules and solar.

In the first exercise it's using PSpice software tools.

The first step is to write the code and describe the electric model of the solar module. The code for calculating the characteristics of the module in the PSpice package is displayed:

```
*****
                                MODULE_1.CIR
*****

.include module_1.lib
xmodule 0 43 42 module_1 params:ta=25,tr=25, iscmr=1.56, pmaxmr=25,
vocmr=21.5,
+ ns=42, np=1, nd=1
vbias 43 0 dc 0
virrad 42 0 dc 1000
.dc vbias 0 23 0.1
.probe
.end
*****
                                MODULE_1.LIB
*****

*   MODEL 1
*   STANDARD AM1.5G 1000 W/m2
*   MODEL DIODE D1
*   CURRENT SOURCE
*   SERIAL RESISTANCE RS
*   MODEL OF DIODE INCLUDE
*   INPUT PARAMETERS: ,STANDAR. TEMPER. CELL,am1.5g
*   TEMPE. AMBIENT Ta
*   IDEALITY OF DIODE ND
*   NS, NUMBER CELLS SERIAL
*   NP, NUMBER CELLS PARALLEL
*   (400)REFERENT
*   (401)INSIDE NODE
*   (402)INPUT
*   (403) IZLAZ
```

```
.subckt module_1 400 403 402 params: ta=1, tr=1, iscmr=1, pmaxmr=1, vocmr=1,
+ ns=1, np=1, nd=1
girradm 400 401 value={{(iscmr/1000*v(402))}}
d1 401 400 diode
.modeldiode d(is={{iscmr/(np*exp(vocmr/(nd*ns*(8.66e-5*(tr+273))))}},n={{nd*ns}}
.func uvet() {8.66e-5*(tr+273)}
.func vocnorm() {vocmr/(nd*ns*uvet)}
.func rsm() {vocmr/(iscmr)- pmaxmr*(1+vocnorm)/(iscmr**2*(vocnorm-
+ log((vocnorm)+0.72))}}
rs 401 403 {rsm()}
.ends module_1.
```

The figures 4. and 5. shows the results of model simulation: I(V) and P(V) characteristics. The simulation is done in the PSpice version 9.1. using data for the given module from the manufacturer:  $N_s = 42$ ,  $P_{max} = 25W$ ,  $I_{scM} = 1.56A$  and  $V_{ocM} = 21.5V$  (standard test conditions STC  $T = 25^{\circ}C$ , AM1.5G,  $1000W/m^2$ ) [11]:

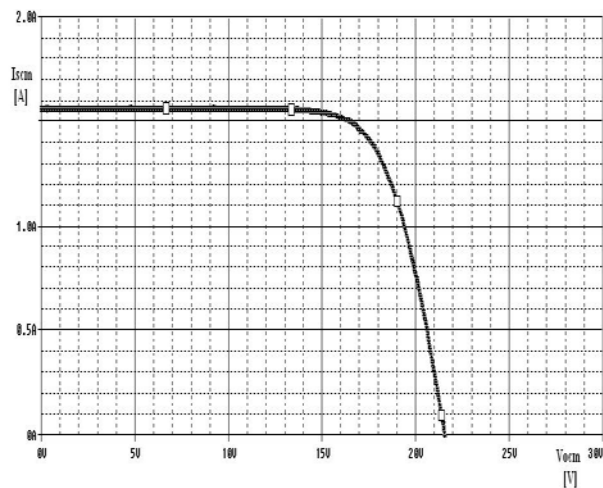

Figure 4. I(V) characteristic of the H250 module obtained by the PSpice program

Power graph in the function of the voltage P(V) characteristics [11].

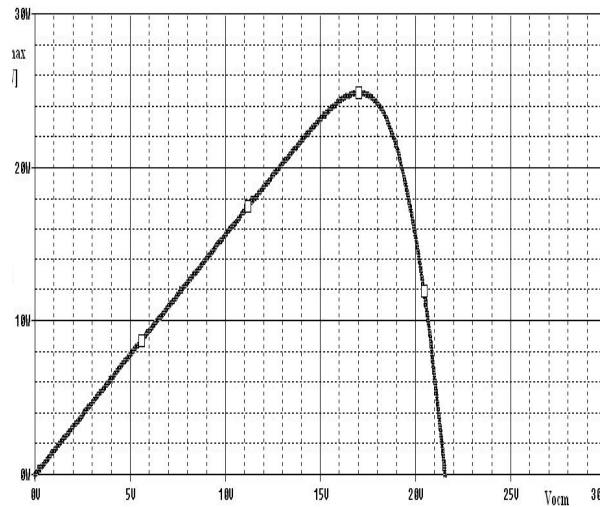

Figure 5. Power graph of the solar module H250 in the function of voltage

Figures 4. and 5. provide the possibility of visual analysis of the characteristics of photovoltaic modules. Students have a visual insight into the behavior of the photovoltaic module in different operating conditions.

*B.The second exercise*

The second exercise is performed using the Matlab/ Simulink package. This package provides the opportunity for students to model photovoltaic modules based on pre-exposed mathematical models.

The good sides of this simulation method of the photovoltaic module is a more detailed insight into the mathematical background of the model. On the other hand, students are given the opportunity to build and enrich the model with new paramters.

In the following fig. 6, the appearance of the photovoltaic module model is made in Simulink® [7].

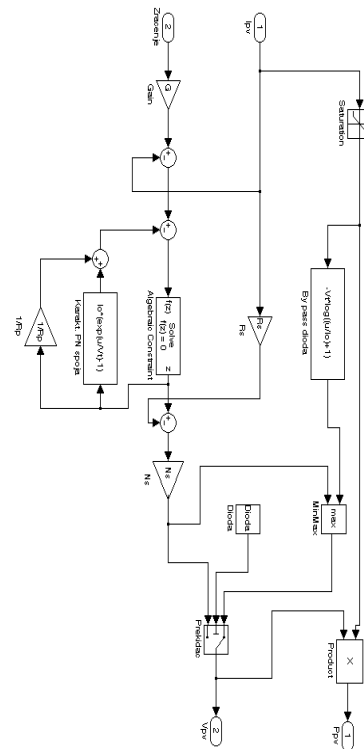

Figure 6. Matlab model of the photovoltaic module made in Simulink®

Results of the simulation of the H250 photovoltaic panel for  $1000\text{W}/\text{m}^2$  brightness intensity with a constant ambient temperature  $T = 300\text{K}$  ( $27^\circ\text{C}$ ), fig.7. and fig.8.

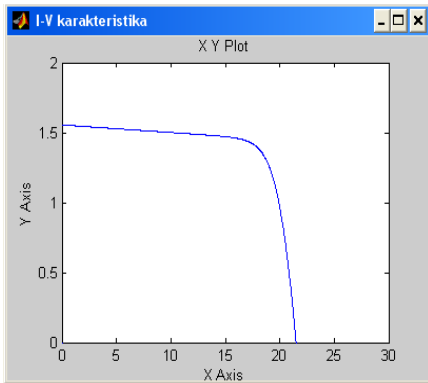

Figure 7. I(V) characteristics Simulink model of module

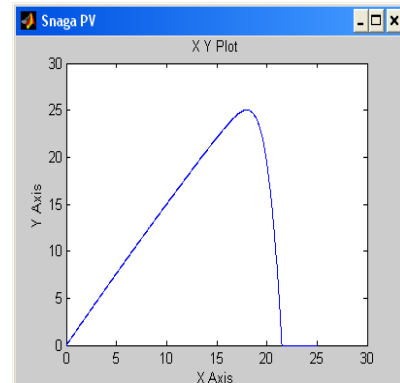

Figure 8. P(V) characteristic Simulink model of module

For the purposes of modeling photovoltaic systems in different environments, where the ambient temperature and radiation intensity are altered, the solar cell model and thus the photovoltaic module without the influence of temperature and intensity of radiation is not accurate enough.

Such models are based on data provided by manufacturers under standard test conditions, which often differ from the changing conditions in which the system operates.

The lack of such a model can be solved using the "behavior" model of the photovoltaic module, which takes into account the influence of the temperature and intensity of radiation on the voltage and current of the photovoltaic module.

The Mask Editor's window prospects for entering M-files and parameters of the photovoltaic module in the Simulink® package are displayed.

Before starting the simulation, enter the "Mask parameters" contained in the "Mask Editor" window. The parameters are the data from the catalog of the manufacturers of photovoltaic modules as already mentioned earlier.

By varying the input data, different types of modules can be analyzed, thus achieving the universality of the proposed model, fig. 9.

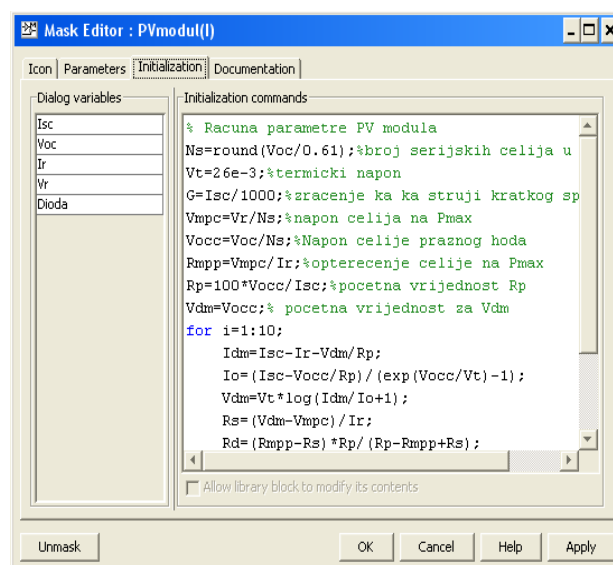

Figure 9. Appearance of Mask Editor for entering m-files for simulation initialization

The results of the simulation of the proposed model for different radiation intensities ( $200\text{W}/\text{m}^2$ ,  $400\text{W}/\text{m}^2$ ,  $600\text{W}/\text{m}^2$ ,  $800\text{W}/\text{m}^2$  and  $1000\text{W}/\text{m}^2$ ), fig.10. and fig. 11.

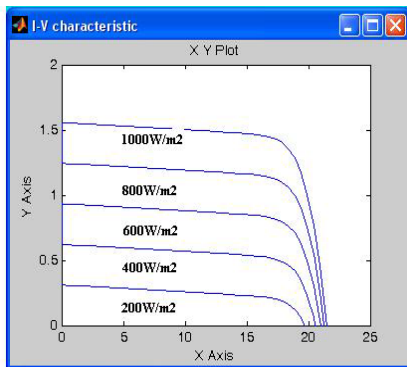

Figure 10. I-V characteristics for different radiation intensities of the module

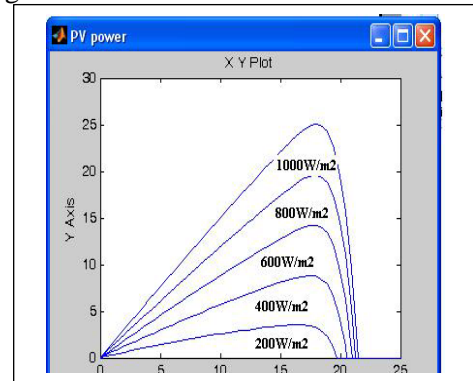

Figure 11. P-V characteristics for different radiation intensities

### C. Third exercise

In the third exercise students using specialized software PVsyst. The software package "PVsyst" has a very large library of solar modules with entered parameters. A good feature of the package is the ability to define new modules with their characteristics. By entering the basic data obtained from the module manufacturer into the program, there is a possibility of simulating the module used in the experiment for different irradiation values with the selected value of solar cell temperature [12].

Simulation of the I-V characteristic made for the values of the Sun radiation from 200 to  $1000\text{W}/\text{m}^2$  in steps of  $200\text{W}/\text{m}^2$ , for cell temperature  $T = 45^\circ\text{C}$  obtained using the package "PVsyst V5.02. Trial version", on fig.12.

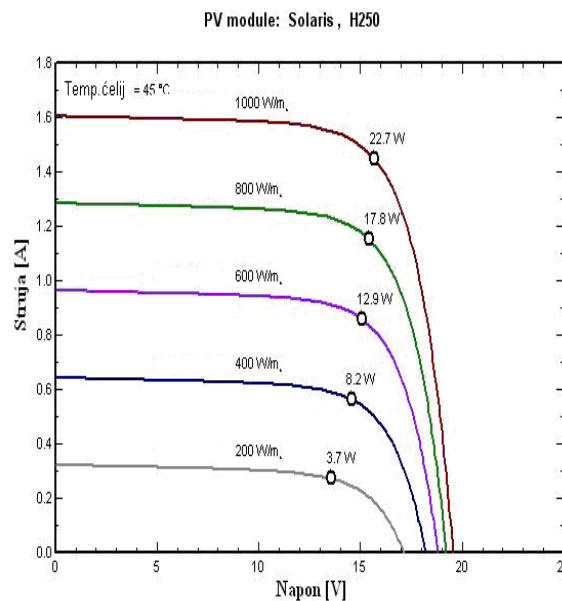

Figure 12. I-V characteristic of the H250 module for  $T = 45^\circ\text{C}$ ,  $G = 200$  to  $1000\text{W}/\text{m}^2$

The dependence of the output power on the level of the irradiation of the module at cell temperature  $T = 45^\circ\text{C}$  is visible on fig. 13.

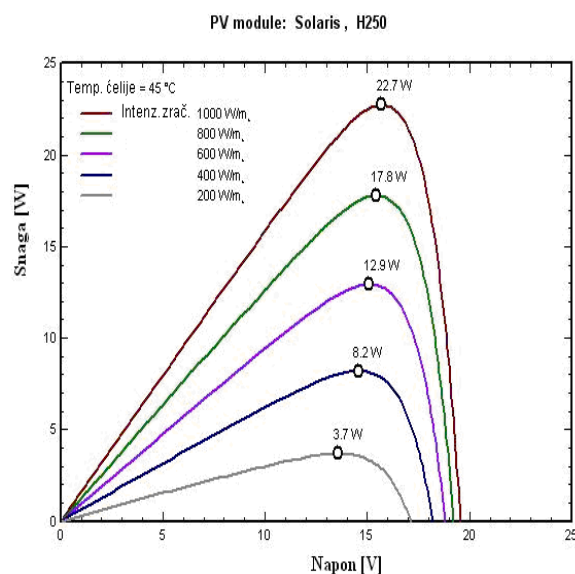

Figure 13. P-V characteristic of module

## VI. RESULTS AND DISCUSSION

Solar energy is a very important source of energy. Today's degree of exploitation of this type of energy is rather small compared to the potentials that it has. Looking back in the past, this form of energy has been on the margin of research and use for a long time. The situation in our country regarding solar energy is still at the beginning, without a more precise plan for the development of this field of energy production. For the above reasons, the role of educational institutions is very important, which will provide the necessary knowledge in this field.

In accordance with the mentioned at the Faculty of Traffic and Transport Engineering in Doboj, a pilot project of student education on the basics of photovoltaic systems was organized. The course was organized to contain theoretical basics and a part that contained the use of various software packages to simulate the behavior of photovoltaic modules and solar cells. Students had the opportunity, based on previously defined mathematical models, to simulate the operation of photovoltaic modules using three different packages, PSpice, Matlab/Simulink and a specialized package for solar systems, Pvsyst.

The trial course was attended by six students of the third year of the Faculty of Traffic and Transport Engineering Doboj, the department of Telecommunication and Postal Traffic. The results of the attendance of the course show that 85% of students marked PVsyst as the software package which is the easiest to use. For deeper analysis of photovoltaic module characteristics, Matlab/Simulink was selected, which over 70% of students selected. During the organization of this pilot project, very important feedback was obtained. This especially refers to the content of theoretical lessons and essences from Matlab/Simulink, PVsyst and PSpice.

## VII. CONCLUSION

The use of modern education facilities, such as simulation tools, increased students' interest in the course and improved their academic results. The course enabled students to acquire advanced knowledge and skills which are beneficial in their later career. The proposed teaching method positively influenced students' satisfaction, participation, and initiative and improved their perception of basic concepts in PV systems.

Today, the situation is very different. In many countries of the world, higher education institutions are open to exclusively researching phenomena related to renewable energy, especially solar energy.

In Australia, at the University of New South Wales (UNSW University Australia), teaching and research in the field of semiconductor solar cells, solar cells in thin film technique, etc. was organized. The aforementioned university deals exclusively with renewable energy sources.



Western Europe takes similar steps. Various projects funded by the governments of developed countries provide relief, then projects of individual users that solar systems place on their facilities are co-financed.

The paper analyzes the possibilities of applying three different software tools for the education of students in the field of renewable energy sources, specifically solar energy.

The students analyze important parameters that characterize solar cells and photovoltaic modules. The mathematical and electronic model of the solar cell and the module is presented.

Based on the models presented, two basic characteristics are described that describe the operation of solar cells and modules, the current-voltage characteristic and the dependence of the output power on the voltage.

For the simulation, students are using three software packages, PSpice, Matlab (Simulink) and PVsyst. From the graphics obtained by the simulations, it is obvious that the graphics mostly coincide and that the proposed models faithfully describe the characteristics of solar cells or modules.

For more detailed study of the fields of photovoltaic modules and solar cells, more detailed mathematical models can be used which take into account the influence of the temperature of the module (cell) on the output power of the module.

#### REFERENCES

- [1] European Commission. (2010). COMMUNICATION FROM THE COMMISSION EUROPE 2020A strategy for smart, sustainable and inclusive growth. Brussels, 3.3.2010.
- [2] EACEA/Eurydice, 2009b. National Testing of Pupils in Europe: Objectives, Organisation and Use of Results. Brussels: EACEA P9 Eurydice.
- [3] Komisija/EACEA/Eurydice, E. (2012). Developing Key Competences at School in Europe: Challenges and Opportunities for Policy. Luksemburg: Ured za publikacije Evropske unije.
- [4] UNESCO, ICT Competency Standards For Teachers, by the United Nations Educational, Scientific and Cultural Organization, United Kingdom
- [5] Christiana Honsberg and Stuart Bowden, "Photovoltaics CDROM", <http://pvedrom.pveducation.org>,
- [6] A.Mc. Evoy, T. Markvart, L. Castaner, Practical Handbook of Photovoltaics Fundamentals and Applications, Second Edition (Elsevier Ltd: 2012.
- [7] Eidelloth S, et al. Simulation tool for equivalent circuit modeling of photovoltaic devices. IEEE J Photovoltaics 2: 572–579. 2012.
- [8] Aparicio MP, et al. Modeling of photovoltaic cell using free software application for training and design circuit in photovoltaic solar energy, <http://www.intechopen.com/books/new-developments-in-renewable-energy/modeling-of-photovoltaic-cell-using-free-software-application-for-training-and-design-circuit-in-pho> (accessed 20 January 2019).
- [9] Luis Castaner and Santiago Silvestre, "Modelling Photovoltaic Systems using PSpice®", John Wiley & Sons Ltd, The Atrium, Southern Gate, Chichester West Sussex, England, 2002.
- [10] R.K. Nema, S. Nema, G. Agnihotri, "Computer Simulation Based Study of Photovoltaic Cells/Modules and their Experimental Verification", International Journal of Recent Trends in Engineering, Vol 1, No. 3, May 2009.
- [11] Mahfoud Abderrezek1, Mohamed Fathi1, Farid Djahli, "Comparative Study of Temperature Effect on Thin Film Solar Cells", JOURNAL OF NANO-AND ELECTRONIC PHYSICS, Vol. 10 No 2, 02027(6pp), 2018.
- [12] M.A. Green, K. Emery, Y.Hishikawa, W.Warta, E.D. Dunlop, Prog. Photovolt: Res. Appl. 24, 905, 2016.

# ASSESSMENT OF STUDENT ICT COMPETENCES IN COMPUTER SCIENCE COURSES

UDC 371.26:378.637]:004

Original research

**Gordana JOTANOVIĆ\***, **Vladimir BRTKA\*\***, **Goran JAUŠEVAC\***, **Aleksandar STJEPANOVIĆ\***,  
**Mirko STOJČIĆ\***

\*Faculty of Transport and Traffic Engineering, Dobož, Republic of Srpska, Bosnia and Herzegovina

\*\*University of Novi Sad, Technical Faculty "Mihajlo Pupin", Zrenjanin, Republic of Serbia

Paper received: 10.10.2017.; Paper accepted: 18.11.2017.

**Abstract:** Improving the ICT competence of students in computer science courses requires an appropriate assessment of the competencies. One of the solutions to this problem is an intelligent system for assessing student ICT competences based on the control of fuzzy logic. The IS is designed so that each part can be expanded and upgraded to a completely new system that is independent of any software environment. Intelligent assessment of ICT student competencies ensures continuous training of students as well as personalization of the learning process based on Competency-Based Education (CBE) and Outcome-Based Education (OBE). The development of the intelligent system is focused on assessing the students' ICT competence without the great influence of teachers.

## I. INTRODUCTION

The rapid developments of information technologies require the continuing IT training students. The question of adequate IT training or competency is no longer an individual problem, but has become a problem of the whole society. The area of the artificial intelligence is being developed in the direction of extending the level of work opportunities for teachers and students [1]. Two basic questions pertaining to Intelligent Systems (IS) are "What the student should learn" and "How to learn" [2]. According to Kabakci Yurdakul et al [3] studies on technology integration in education have changed from technology-based Information and Communication Technologies (ICT) education approaches towards pedagogy-based approaches. The rapid development of new education technologies caused the learning and teaching processes to change as well [4]. The knowledge, which students acquire, based on critical and creative transformations of syllabus, will be more valuable than the knowledge gained through cognition, reproduction and gathering information [5]. Rightfully we can expect faculties to follow innovative processes and to educate young experts in accordance with the needs of society and economy. According to Elfaki et al [6] computing becomes a primary key in the education system. Development of multimedia applications designed for personal computers offer more possibilities for creating Computer Science Courses (CSC) with picture and sound, as well as animated films, so by following the syllabus, students can independently make progress in learning [7]. If necessary they can go back to the content which was not precise enough or in compliance with abilities and interests of students. Educational systems, which can be based on the principles of artificial intelligence, come into existence in this modern digital environment. Functioning of these systems was based on hypertext, and the system consisted of supervised materials with the curriculum based on multiple choice questions, which took the user through expert base depending on the provided answers to the given questions [8]. Assessing competence of students is an important problem in the educational system because it complements the knowledge and skills of students. In order to solve this problem we included pedagogical paradigm and intelligent

component. This form of teaching and assessment of ICT competencies meets the needs and interests of young people and to learn in accordance with their capabilities [9]. According to Balogh, Turcan & Magda [10] educational institutions should behave as organizations that provide education, improving competence and knowledge assessment, are explained with two words "educational services".

#### *A. Student ICT competencies in Computer Science Courses*

Studying ICT competencies of students, as well as models CSC, have long been engaged in countries where the ICT competencies of teachers and students at the high level of development. These models have long been used in the countries of the European Union. There are a significant number of professional and scientific publications as well as national strategies in the field of ICT competencies. Special importance is given to the competence of teachers, students and the national strategy their improvement. The intensive development of Information and Communication Technologies indicates the need for continuous improvement of educational processes ([11], [12], [13], [14], [15], [16], [17]). Recognizing the problem, European Commission created the strategy "Europe 2020", which was established five main objectives that include employment, research and development, climate change/energy, education, social inclusion (poverty reduction) [11]. In this way, are strictly defined key ICT competencies, which greatly facilitate their harmonization and improvement?

The globalization of business processes and processes in education requires the education system to constantly improve ICT competence standards for students and teachers. Through education, students need to achieve appropriate ICT competence standards in order to be competitive in the employment market. The statute of limitations and rigidity of the curriculum and not a quality assessment of competence of students in elementary, high and university education prevents students sufficient flexibility and efficiency to the employment market. The Europa 2020 strategy is one of the initiatives aimed at student mobility. By creating ICT standards for assessing ICT competence of students and their harmonization with European standards, students would be able to increase mobility, in order to achieve a higher quality of education system.

Standardized tools for evaluation of digital competence are fairly widespread throughout Europe [12]. European certified document, European Computer Driving License (ECDL) regularly or occasionally used in approximately half of European countries.

#### *B. Assessment of student ICT competences*

One of the most important activities in improving student's ICT knowledge and skills is good quality assessment of current student's competencies. The problem occurs if the student ICT competencies are not well estimated. For example, when teachers assess students' knowledge scores: insufficient (1), sufficient (2), good (3), very good (4) and excellent (5), and when it cannot decide what grades he deserved a particular student. In this case, teachers use a method of rough sets. Teachers personal form sets in which students type marks (5), (4+), (3), (1+), (2-) ...

In this case, a universal set is a set of all students with grades: insufficient (1), sufficient (2), good (3), very good (4) and excellent (5), and its subset is composed of students (5- ), (4+), (3-), (1+), (2-) that agree with the above assertion. From the example shows that it is not a classic set; because there are students who are only to some extent satisfy the claim. Due to the uncertainty that occurs in these and similar situations, the need arises to describe them mathematically with the help of fuzzy sets. Fuzzy sets in this case represents the generalization of the classical set, since each element determines the degree of belonging to a set [18].

## II. INTELLIGENT ASSESSMENT OF STUDENT ICT COMPETENCIES

The research problem is that students are often required to attend computer science courses assuming you already have some ICT competence in the field of course. However, many teachers have the perception that students are becoming more computer-competent, especially new Net-generation students or for no validation [19, 20].

An intelligent system assesses students' ICT competences through smart student knowledge management. This system can help the teacher at a certain level for assessment of the student's ICT competence in the traditional education system. It is also applicable in assessing ICT competencies of students in new educational paradigms. The system is designed exclusively for Competency-Based Education (CBE), and at a lower level of Outcome-Based Education (OBE) [21]. These are education systems, where the student progresses by demonstrating his / her competence while "living" or a "virtual" teacher leads through the system [21]. OBE has been implemented in most countries of the European Union at the level of university education so that intelligent system can have great applicability [22].

The system for assessing students' ICT competences is designed based on the fuzzy logic management process. The Intelligent System (IS) consists of a Fuzzy Logic Controller (FLC). The process is designed so that the structure of the FLCs that are connected in a regular or parallel manner corresponds to a modular structure of teaching based on Computer Science Courses. Simulation of FLC is carried out in the Java programming language. For example is used ECDL standard (Word Processing). The structure of the tree of the learning module Word processing is mapped to the organization of the FLCs. The FLC management system consists of input values in the form of learning outcomes (TI) and FLCs connected in a regular and parallel structure. Organization of FLC's based on the principle of the tree consisting of branches and nodes. The branches of the system at a certain level a conclusion is input to the next output of FLC, this is not the case only with the initial level.

*Branch 1*

The Branch 1 comprises a Node 1, Node 2 and Node 1 Node 3rd: 5 comprise the input TI System Controller WWD (Working with Documents). Node 2: contains for EP controller (Enhancing Productivity) and 4 TIs. Node 3: contains two input controllers WWD and EP and one output controller UA, Figure 1.

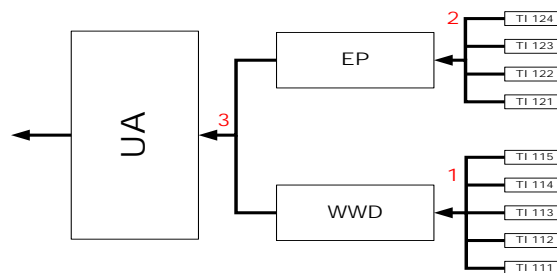

Figure 1. Graphical presentation of the FLC layout in the Branch 1.

Node 1: consists of five input TIs (TI 111, TI 112, TI 113, TI 114 and TI 115) that are regularly associated with the WWD WWD. Node 2: consists of four input TIs (TI 121, TI 122, TI 123 and TI 124) that are regularly connected to the FLC EP. At node 3, the WWD and EP are interconnected parallel controllers and regularly with the UA fuzzy controller.

*Branch 2*

The Branch 2 consists of Node 4, Node 5, and Node 6. Node 4: contains 3 input TIs for the ET controller (Enter Text). Node 5: contains for EP controller (Select, Edit) eight TIs. Node 6: contains two input controllers ET and SE and one output controller DC (Document Creation), Figure 2.

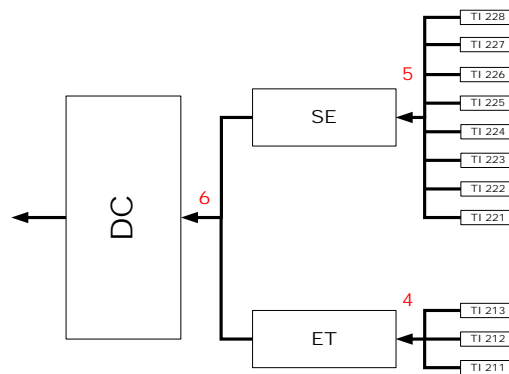

Figure 2. Graphical presentation of the FLC layout in the Branch 2.

Node 4 consists of three input TIs (TI 211, TI 212 and TI 213) that are regularly connected to FLC ET. Node 2 consists of eight input TIs (TI 221, TI 222, TI 223, TI 224, TI 225, TI 226, TI 227 and TI 228) that are regularly connected to the FLC SE. At node 3 ET and SE are interconnected parallel controllers and regularly with DC fuzzy controller.

*Branch 3*

The Branch 3 contains the highest number of input variables. It consists of 19 entrance TIs and four nodes. Thus, it contains Node 7, Node 8 and Node 9 and Node 10. Node 7: Contains 5 input TIs for controller T (Text). Node 8: contains for controller P (Paragraphs) 4 TIs. Node 9: contains for controller S (Styles) 2 TIs. Node 10: contains three input controllers T, P and S and one output controller F (Formatting), Figure 3.

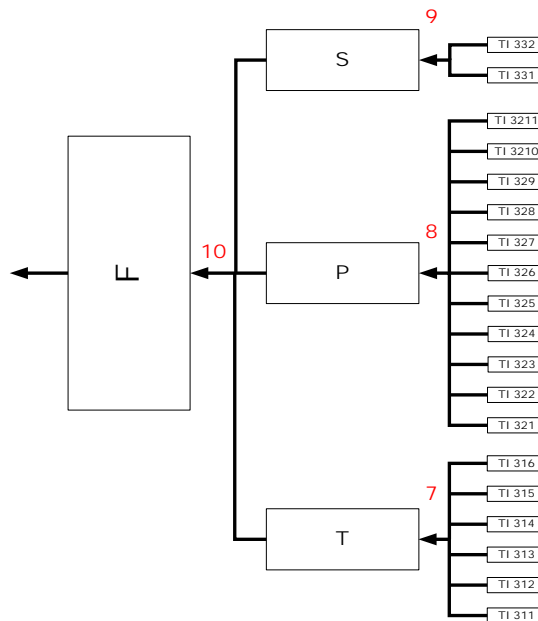

Figure 3. Graphical display of FLC layouts in the Branch 3.

Node 7: consists of six input TIs (TI 311, TI 312 and TI 313, TI 314, TI 315 and TI 316) that are in regular connection with FLC (T). The node 8 consists of 11 input TI- TI 321, TI 329, TI 3210, TI 321, TI 3210, TI 324, TI 323, TI 324, TI 326, TI 326, TI 3210, TI 3210 and TI 3211) that are regularly associated with the P (Paragraphs) FLC. Node 9 consists of two inputs (TI 331 and TI 332) for the S (Styles) controller. At node 10 T, P and S are interconnected parallel controllers and regularly with F fuzzy controller.

*Branch 4*

The Branch comprises four Node 11, Node 12 and Node 13 and Node 11 on the 14th Node: contains 4 inputs TI System Controller TC (Table Creation). Node 12: contains for the TF (Table Formatting) controller and three TIs. Node 13: contains three TIs for GO (Graphical Objects) controller. Node 14: contains three input controllers TC, TF and GO, and one output controller O (Objects), Figure 4.

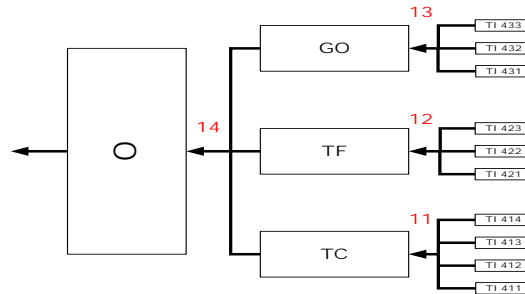

Figure 4. Graphical representation of the FLC layout in the Branch 4.

Node 11 consists of four input TIs (TI 411, TI 412 and TI 413 and TI 414) that are regularly connected to the FLC TC. Node 12: consists of three input TIs (TI 421, TI 422 and TI 423) that are regularly connected to the FLC TF. Node 13: consists of three inputs (TI 431, TI432 and TI433) for the GO controller. In Node 14 TC, TF and GO are parallel-connected controllers and regularly with the O fuzzy controller.

*Branch 5*

The Branch 5 consists of Node 15, Node 16, and Node 17. Node 15: contains 3 input TIs for P (Preparation) controller. Node 16: contains two TIs for the O (Outputs) controller. Node 17: contains two input P and O controllers and one MM Output Controller (Mail Merge), Figure 5.

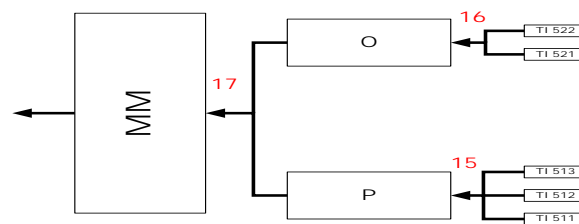

Figure 5. Graphical representation of the FLC layout in the Branch 5.

Node 15 consists of three input TIs (TI 511, TI 512 and TI 513) that are in regular connection with FLC P. The node 16 consists of two input TIs (TI 521 and TI 522) that are in regular connection with FLC O. At Node 17 P and O are interconnected parallel controllers and regularly with MM fuzzy controller.

*Branch 6*

The Branch 6 consists of Node 18, Node 19 and Node 20. Node: 7 comprise the input TI System Controller S (Setup). Node 19: contains the CAP (Check and Print) controller and four TIs. Node 20: contains two input controllers S and CAP and one output controller PO (Prepare Outputs), Figure 6.

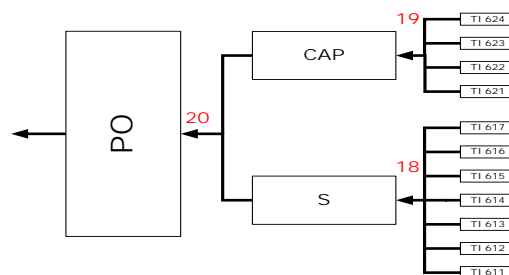

Figure 6. Graphical representation of the FLC layout in the Branch 6.

Node 18 consists of seven input TIs (TI 611, TI 612, TI 613, TI 614, TI 615, TI 616, and TI 617) that are in regular connection with FLC S. The node 19 consists of four inputs TIs (TI 621, TI 622, TI 623 and TI 624) that are regularly associated with the FLC CAP. At Node 20 S and CAP are interconnected parallel controllers and regularly with PO fuzzy controller.

*Branch 7*

The Branch 5 represents the highest level in the design of the "tree". Node 21: consists of the six previously mentioned (UA, DC, F, O, MM and PO) interconnected parallel controllers and connected regularly to the WP controller, Fig. 7. The referenced controllers were at the lower level of the hierarchical structure representing output controllers in this case are input controllers.

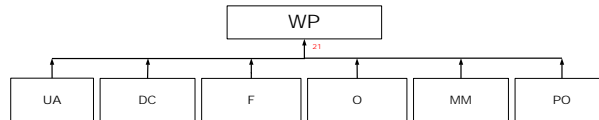

Figure 7. Graphical representation of the FLC layout in the Branch 7.

Implementation of FLCs in an intelligent management system is reduced to writing a program code (Java programming language). Intelligent assessment of the student's ICT competency is based on the default value of achievement in mastering the teaching contents. The specified value is retained until there is a need for some other value in the system. Before writing a program code for system simulation, an analysis of the process of managing an intelligent assessment of ICT competences was required. The purpose of the simulation is to use the alpha algorithm to describe the appearance of the IS in a mathematical way so that the practical realization of the intelligent assessment of knowledge in the real system fulfills the goals.

### III. METHOD

The method of research is realized through the simulation of FLC's in the experimental testing of ICT competencies of students in CSS. The aim of the experiment was not designing a commercial software environment of intelligent systems. The goal was to test the management of student learning outcomes (TI) using FLCs and their delivery based on values obtained using the Alfa algorithm. The conceptual design of the experiment was based on Java Applet programming that will be used to calculate the Alpha value, WWD, EP and UA MFIS. The program code was created in Eclipse environment using the Java Development Kit (JDK) technology in the form of the Appletviewer tool.

The purpose of the research is to use IS to understand students' readiness to improve ICT competences. It also uses it to assess student knowledge. Prediction performance of students in the system is done using the initial value of the estimated students' knowledge on the level of learning outcomes. Therefore, the assessment of the ICT competence of the student should produce convincing parameters of the student's knowledge, which is important for the further operation of the system.

IS model is based on estimated achievements of student learning outcomes (TI) received from teachers. Students achievements are represented by the number of points based on which the system forms a parametric function with one argument, i.e. the function of affiliation with the parameters a, b, and c, which corresponds to the degree of student achievement in relation to the specific learning outcome of TI. The number of points a value of the parameter b membership functions. The values of the parameters a and c is determined on the basis of empirical experience and teaching skills based on principles of assessment. Valuation of parameters a, c in this case is determined on the basis of the assessment that is based on the pedagogical principle of evaluation. During the assessment we assume that the student be wrong to answer the question that he knows the answer or the correct answer to the question that you do not know the answer. The question is how much the student's level of tolerance in assessing ICT competences is? The maximum number of points a student can achieve on the test is 100 points, giving the student the opportunity to incorrectly answer one question that is worth 10 points, so that the estimated tolerance in the concrete case is 10% and in the scoring system it is 10 points. The

membership function formed on the basis of the above parameters is symmetric so that the specified value of the parameters a, c is as follows:

$$a = (b-10) \quad (1)$$

$$b = (b+10) \quad (2)$$

The value of the parameter b in (1) and (2) is expressed by the number of points gained by a student at the assessment. The triangular symmetric membership function for TI with certain values of parameters a, b and c is graphically depicted in Figure 8.

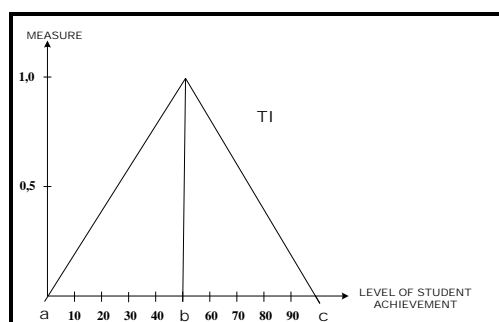

Figure 8. Triangular membership functions with values of the parameters a, b and c.

Cases of these membership functions shown in Figure 8, parameter  $b = 50$ , the values of this parameter depend on the values of the parameters  $a = 0$  and  $c = 100$ . Behavior of membership function for different values of parameters a, b, and c of only one learning outcome T111, Figure 8.

IS testing was done in the Applet written in a Java programming language that was designed exclusively for the purpose of the experiment. Applet has a function of calculating Alfa algorithm, the value of FLC's WWD, EP and UA on the basis of which the system gives the proposal of teaching lessons that is appropriate for the student. The teaching lesson contains a number of learning outcomes (TI).

To avoid the phenomenon of a situation where students are "stuck" in the process of assessing competencies, so-called "Point-spinning", the system has been tested for the limit values of parameters a, b and c where possible errors in system operation (3) and (4).

$$a=b=c=0 \rightarrow \alpha = 0 \quad (3)$$

$$a=b=c=100 \rightarrow \alpha = 0 \quad (4)$$

Cases of boundary values of the membership function are described in (3) and (4).

In the first case, all parameters of the function are equal to each other and equal to zero (3). In the above case  $\alpha = 0$ , the student has minimal achievement from all teaching content so that the system does not have anything to recommend for him, the following message is learned by the complete CSS.

The second case is when all parameters of the function are equal to one another and equal to 100, that is, the maximum value of the function of belonging (4). In this case,  $\alpha = 0$ , the student has the maximum achievement from all learning outcomes so that the system does not have anything to specifically recommend, the message would be competent for the student to move to a higher level of training in this field. In order for the IS to function correctly, it is recommended to discover at the outset the causes of extreme behavior of the system and eliminate at an early stage.

For the purpose of the research with the different values of the parameters (a, b, c) for the learning outcome T111, which represents the function of affiliation and the values of the parameter (a, b, c) for the lesson (NL) that should be delivered to verify the student's ICT. For conditions that observes the behavior of an intelligent system for concrete values  $\alpha$  -s, WWD, EP, A, NL-teaching lessons. For the purpose of the experiment, 7 teaching lessons L1, L2, L3, L4, L5, L6 and L7 were modeled.



#### IV. RESULTS AND DISCUSSION

The research results represent the behavior of Student 1 in the evaluation of ICT skills in CSS. Student 1 is modeled exclusively for the purpose of implementing the system. The student's ICT competence assessment parameters are simulated to match the parameters in the real system. Table I shows the results of the assessment of ICT competences in CSS modeled Student 1 from the learning outcome T111, the values of the parameters a, b, and c for the limit values of the corresponding membership function.

TABLE I. RESULTS OF TESTING T111 PARAMETER VALUES A, B AND C LIMIT VALUES MEMBERSHIP FUNCTIONS. RESULTS OF TESTING T111 PARAMETER VALUES A, B AND C LIMIT VALUES MEMBERSHIP FUNCTIONS

ID	T 111	WWD	EP	UA	α	NL
1.	(0,0,0)	15,2	21,45	10,70	0	0
2.	(100,100,100)	15,2	21,45	10,7	0	0
3.	(0,100,100)	15,2	21,45	10,7	0	0
4.	(0,0,100)	15,2	21,45	10,7	0	0

T111-nastavni sadržaj (TI); WWD, EP i UA- FLC; α-kalkulator za prijedlog nastavne lekcije; NL-nastavna lekcija.

Based on the data shown in Table I we can see that these are few special cases for the value of the student's achievements learning outcome T111, which have previously explained in (3) and (4).

In these cases, the values of the FLCs (WWD, EP and UA) have some constant value, which tells us that when changing the value of only one TI, there is no change in the calculation of the FLCs, Figure 9. The values of  $\alpha$ -e are also not changed for all the achievement values of the T111. Based on the value of  $\alpha = 0$ , no teaching lesson is recommended for further checking competencies. Figure 9 graphically depicts the ratio of the values shown in Table I., so that the values for all the quantities used in the calculations are unchanged for the different values of the Student 1 achievement from the learning outcome T111.

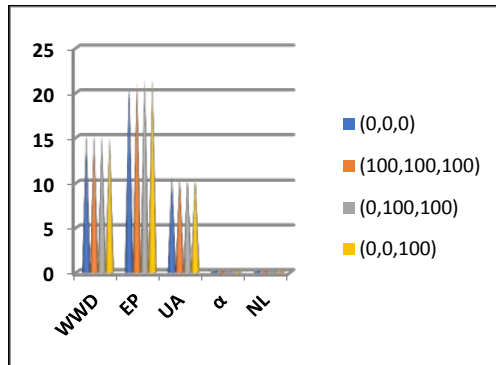

Figure 9. The values of  $\alpha$ , FLCs and the lesson proposal NL for T111.

Table II shows the results of the Student 1 achievement of learning outcomes for the T111 parameter values a, b and c that are moving in the range [80, 100]. From Table II we can see that the values of the parameters a, b are decremented parameter c = 100, which means that the right boundary examine the membership function T111. From the enclosed, we see that the system does not offer a Student 1 lesson to check student ICT competencies. This means that Student 1 has reached the maximum value in the competency check and will have to move to a higher level of competence examination (4). An interesting observation is marked in row 1 of the parameter values of membership functions T111 (80, 90, 100) which is particularly characterized in Table II In the right values of the changes of  $\alpha$ -e,  $\alpha = 1$  for which the system proposes the Student 1 lesson (L6) from which the following should examine the competence. Based on the results shown in Table II, we can observe that the values of FLC's WWD, EP, and UA are not changed, so we will no longer consider them until they are interesting.

TABLE II. THE VALUE OF THE PARAMETER RANGE IN THE INTERVAL [80,100].

ID	T 111	WWD	EP	UA	$\alpha$	NL
1.	(80,90,100)	15,2	21,45	10,70	1	L6
2.	(81,91,100)	15,2	21,45	10,7	0	0
3.	(82,92,100)	15,2	21,45	10,7	0	0
4.	(83,93,100)	15,2	21,45	10,7	0	0
5.	(84,94,100)	15,2	21,45	10,7	0	0
6.	(85,95,100)	15,2	21,45	10,7	0	0
7.	(86,96,100)	15,2	21,45	10,7	0	0
8.	(87,97,100)	15,2	21,45	10,7	0	0
9.	(88,98,100)	15,2	21,45	10,7	0	0
10.	(89,99,100)	15,2	21,45	10,7	0	0
11.	(90,100,100)	15,2	21,45	10,7	0	0

Figure 10 is a graphical representation of the results from Table II. We can see that the values of WWD (15.2), EP (21.45) and UA (10.7) are not altered,  $\alpha = 1$ , and the proposal of the lesson for competence verification is L6.

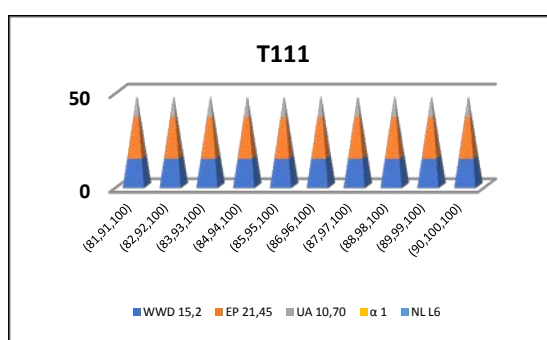

Figure 10. Relationships of the T111 values and the magnitudes shown in the legend of the graphic.

Table III shows the results of the degree of competence assessment of Student 1 from learning outcomes T111 for the values of parameters moving in the interval [70, 90]. The values of the parameters a, b are decremented,  $c = 90$ .

Special attention will be paid to row 11 which is marked in Table III, where  $\alpha = 1$  and for the study of Student 1 competence. L7 lesson is proposed for assessment of Student 1 ICT competences. Based on the Alfa ( $\alpha$ ) value, the system determines a lesson that is more compatible for Student 1, in this case, it is a L7 lesson.

TABLE III. PARAMETER VALUE FOR STUDENT 1 THAT ARE MOVING IN THE RANGE [70,90].

ID	T 111	WWD	EP	UA	$\alpha$	NL
1.	(80,90,90)	15,2	21,45	10,7	1	L6
2.	(79,89,90)	15,2	21,45	10,7	0,90	L6
3.	(78,88,90)	15,2	21,45	10,7	0,84	L6
4.	(77,87,90)	15,2	21,45	10,7	0,77	L6
5.	(76,86,90)	15,2	21,45	10,7	0,72	L6
6.	(75,85,90)	15,2	21,45	10,7	0,67	L6
7.	(74,84,90)	15,2	21,45	10,7	0,63	L6
8.	(73,83,90)	15,2	21,45	10,7	0,59	L6
9.	(72,82,90)	15,2	21,45	10,7	0,55	L6
10.	(71,81,90)	15,2	21,45	10,7	0,53	L6
11.	(70,80,90)	15,2	21,45	10,70	1	L7

Figure 11 shows the percentage of alpha ( $\alpha$ ) for certain values of T111. The learning outcome T111 with different parameter values (a, b, c) was observed. With the graphic of Figure 11 we can see that the values of the parameters (a, b, c) fall, thus decreasing the alpha value.

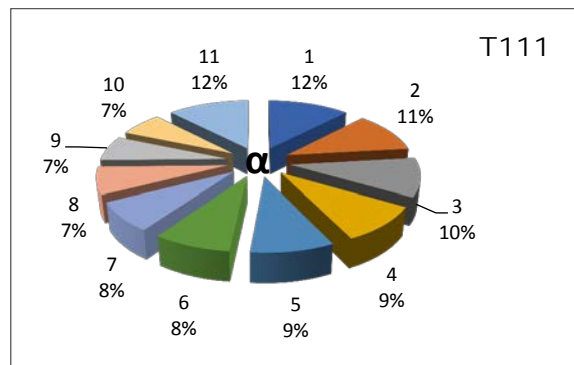

Figure 11. The percentage of alpha ( $\alpha$ ) for different values of T111 is taken from Table III.

The intervals observed until a value of T111 was performed to decrementation values of the parameters a, b, c. Parameter value was unchanged, which means that we have examined the right border of the function belonging to the T111. The intervals from which the T111 values are examined are in the central range of membership functions. Based on the results shown in Table IV, we see that in only one case the system checks the students' competencies from the L6 lesson for  $\alpha = 0.5$  is the central part of the scope of the T111 membership function, for the left and right limits  $\alpha = 1$ .

TABLE IV. STUDENT 1 RESULTS FOR THE VALUE OF THE PARAMETER MOVING IN THE INTERVAL [60,90].

ID	T 111	$\alpha$	NL
1.	(60,70,80)	0,5	L6
2.	(61,71,81)	0,55	L7
3.	(62,72,82)	0,60	L7
4.	(63,73,83)	0,65	L7
5.	(64,74,84)	0,70	L7
6.	(65,75,85)	0,75	L7
7.	(66,76,86)	0,80	L7
8.	(67,77,87)	0,85	L7
9.	(68,78,88)	0,90	L7
10.	(69,79,89)	0,95	L7
11.	(70,80,90)	1	L7

Figure 12 shows calculations of alpha for different values of T111. We can notice that the alpha values are 9% except in one case where the alpha is equal to 10% for the T111 (60, 70, 80) in this case it is the teaching lesson L6.

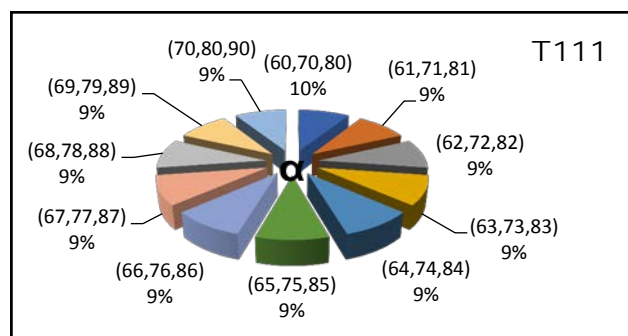

Figure 12. The percentage of alpha ( $\alpha$ ) for different values of T111 is taken from Table IV.

The value of parameters a, b and c range approaching the central part of the membership function proportionally decreasing values for alpha. From Table V we can see that the values of the parameters (50, 60, 70)  $\alpha = 0$ , the Student 1 does not propose any lesson for assessment.

TABLE V. STUDENT 1 RESULTS FOR THE VALUE OF THE PARAMETER MOVING IN THE INTERVAL [50,80].

ID	T 111	$\alpha$	NL
1.	(60,70,80)	0,5	L6
2.	(59,69,79)	0,45	L7
3.	(58,68,78)	0,40	L7
4.	(57,67,7)	0,35	L7
5.	(56,66,76)	0,30	L7
6.	(55,65,75)	0,25	L7
7.	(54,64,74)	0,20	L7
8.	(53,63,73)	0,15	L7
9.	(52,62,72)	0,10	L7
10.	(51,61,71)	0,05	L7
11.	(50,60,70)	0	0

Figure 13 shows the values of  $\alpha$ , the value of parameter b tends to values approximately equal to 50.

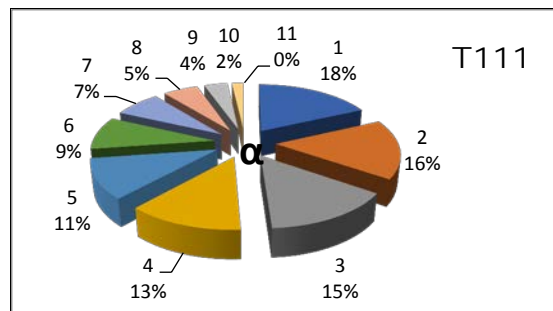

Figure 13. The percentage of alpha ( $\alpha$ ) for different values of T111 is taken from Table V.

Table VI shows that the modeled values of the parameters (a, b, c) for T111 are approaching the left limit of the function; in proportion, the alpha value decreases from 0.5 to a value of 0.05 and then gets the value  $a = 1$  for which the transfer is made to lesson L3. Other values of the alpha, system does not propose to the Student 1 any learning outcome for further assessment of the student's ICT competence.

TABLE VI. STUDENT 1 RESULTS FOR THE VALUE OF THE PARAMETER MOVING IN THE INTERVAL [40,70].

ID	T 111	$\alpha$	NL
1.	(50,60,70)	0,5	0
2.	(49,59,69)	0,45	0
3.	(48,58,68)	0,40	0
4.	(47,57,67)	0,35	0
5.	(46,56,66)	0,30	0
6.	(45,55,65)	0,25	0
7.	(44,54,64)	0,20	0
8.	(43,53,63)	0,15	0
9.	(42,52,62)	0,10	0
10.	(41,51,61)	0,05	0
11.	(40,50,60)	1	L3

Figure 14 shows the percentage values for a-a, the values of a-a decrease in proportion to the decreasing value of parameters a, b, and c. The alpha value for T111 (40,50,60) is growing at 27%.

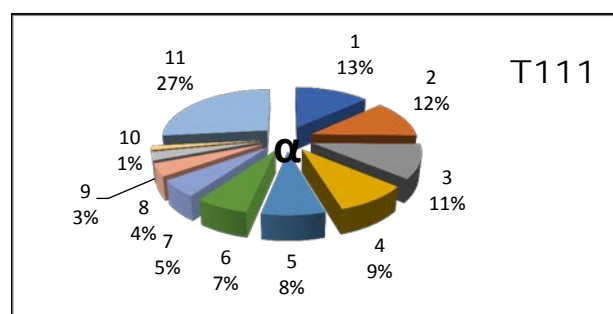

Figure 14. The percentage of alpha ( $\alpha$ ) for different values of T111 is taken from Table VI.

Table VII shows values for T111 that are close to the left limit of the function of belonging. Switching to a new lesson L2 is performed for the values of the T111 function parameters (30, 40, 50).

TABLE VII. STUDENT 1 RESULTS FOR THE VALUE OF THE PARAMETER MOVING IN THE INTERVAL [30,60].

ID	T 111	$\alpha$	NL
1.	(40,50,60)	1	L3
2.	(39,49,59)	0,95	L3
3.	(38,48,58)	0,90	L3
4.	(37,47,57)	0,85	L3
5.	(36,46,56)	0,80	L3
6.	(35,45,55)	0,75	L3
7.	(34,44,54)	0,70	L3
8.	(33,43,53)	0,65	L3
9.	(32,42,52)	0,60	L3
10.	(31,41,51)	0,55	L3
11.	(30,40,50)	1	L2

A special accent was placed on the value of T111 parameter (40, 50, 60) and T111 (30, 40, 50) for which the value of alpha are row 1 (12%) and row 11 (11%), Figure 15.

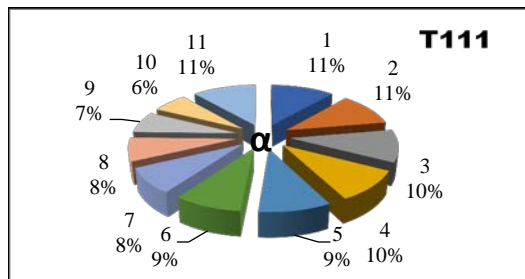

Figure 15. The percentage of alpha ( $\alpha$ ) for different values of T111 is taken from Table VII.

The references in Table VIII show that values for the FLC WWD change, which was not the case until then. For T111 (20, 30, 40) value of WWD is 14.95, EP and UA have unchanged values. WWD value declined from 15.20 to 14.95 for the reason that a small value of T111 parameter (20, 30, 40) is one of the inputs of the FLC WWD. In addition, the values of the WWD are also declining in value for the alpha. The lowest alpha value is for T111 (11, 21, 31),  $\alpha = 0.05$  and for T111 (10, 20, 30)  $\alpha = 1$ . The values of  $\alpha = 1$  for T111 (10, 20, 30) cause a change in the lesson L2 in L1.

TABLE VIII. STUDENT 1 RESULTS FOR THE VALUE OF THE PARAMETER MOVING IN THE INTERVAL [10,50].

ID	T 111	WWD	EP	UA	$\alpha$	NL
1.	(30,40,50)	15,2	21,45	10,7	1	L2
2.	(29,39,49)	15,2	21,45	10,7	0,95	L2
3.	(28,38,48)	15,2	21,45	10,7	0,90	L2
4.	(27,37,47)	15,2	21,45	10,7	0,85	L2
5.	(26,36,46)	15,2	21,45	10,7	0,80	L2
6.	(25,35,45)	15,2	21,45	10,7	0,75	L2
7.	(24,34,44)	15,2	21,45	10,7	0,70	L2
8.	(23,33,43)	15,2	21,45	10,7	0,65	L2
9.	(22,32,42)	15,2	21,45	10,7	0,60	L2
10.	(21,31,41)	15,2	21,45	10,7	0,55	L2
11.	(20,30,40)	14,95	21,45	10,7	0,50	L2
12.	(19,29,39)	14,45	21,45	10,7	0,45	L2
13.	(18,28,38)	13,95	21,45	10,7	0,40	L2
14.	(17,27,37)	13,45	21,45	10,7	0,35	L2
15.	(16,26,36)	12,95	21,45	10,7	0,30	L2
16.	(15,25,35)	12,45	21,45	10,7	0,25	L2
17.	(14,24,34)	11,95	21,45	10,7	0,20	L2
18.	(13,23,33)	11,45	21,45	10,7	0,15	L2
19.	(12,22,32)	10,95	21,45	10,7	0,10	L2
20.	(11,21,31)	10,45	21,45	10,7	0,05	L2
21.	(10,20,30)	9,95	21,45	10,7	1	L1

Figure 16 shows that alpha values are below the indicated value of  $\alpha = 0.50$ .

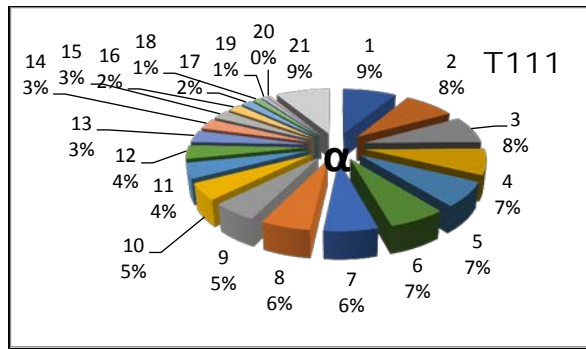

Figure 16. The percentage of alpha ( $\alpha$ ) for different values of T111 is taken from Table VIII.

Table IX shows that the declining alpha values have no impact on the change of L1 lesson. The values of the FLC's WWD are also declining with the decrease in the values of the parameters a, b, and c. The behavior of the membership function for the decimal values of the parameter a, that is left limit of the function of affinity, was tested, therefore we can see that the values for the alpha in both cases were not changed and amounted to  $\alpha = 0.47$ .

TABLE IX. STUDENT 1 RESULTS FOR THE VALUE OF THE PARAMETER MOVING IN THE INTERVAL [0.50,30].

ID	T 111	WWD	EP	UA	$\alpha$	NL
1.	(10,20,30)	9,95	21,45	10,7	1	L1
2.	(9,19,29)	9,50	21,45	10,7	0,95	L1
3.	(8,18,28)	9,00	21,45	10,7	0,89	L1
4.	(7,17,27)	8,50	21,45	10,7	0,84	L1
5.	(6,16,26)	8,00	21,45	10,7	0,79	L1
6.	(5,15,25)	7,50	21,45	10,7	0,74	L1
7.	(4,14,24)	7,00	21,45	10,7	0,68	L1
8.	(3,13,23)	6,50	21,45	10,7	0,64	L1
9.	(2,12,22)	6,00	21,45	10,7	0,58	L1
10.	(1,11,21)	5,50	21,45	10,7	0,53	L1
11.	(0,10,20)	5,00	21,45	10,7	0,47	L1
12.	(0.90,12,22)	5,00	21,45	10,7	0,47	L1
13.	(0.5,11,21)	5,00	21,45	10,7	0,47	L1

Figure 17 shows percentages of the alpha where we can notice that the decimal values for the alpha less than 0.5, specifically 0.47. Alpha have a percentage of 5% which does not change if we change the values of the parameters a, b, and c.

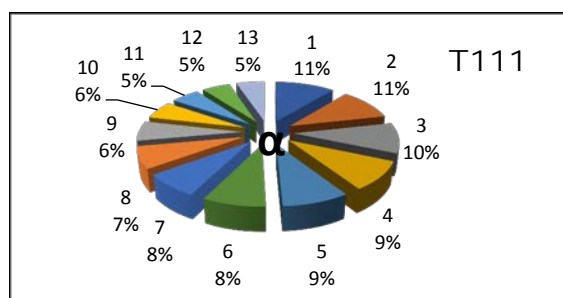

Figure 17. The percentage of alpha ( $\alpha$ ) for different values of T111 is taken from Table IX.

By studying the observation of Table X we can notice that the values of the parameter  $a = 0$  are unchanged, which means that we are examining the left limit of the T111 membership function. Just as with the right frontier, we have a special case where the system does not offer Student 1 a single lesson for competence checking (3). Therefore, Student 1 examined the competencies from all seven teaching lessons. For the T111 (0, 0, 0) value, the FLC value of WWD is zero, which shows that there is no longer a need for further assessment of Student's ICT competencies, because the level of assessed competencies is minimal.

TABLE X. STUDENT 1 RESULTS FOR THE VALUE OF THE PARAMETER MOVING IN THE INTERVAL [0,20].

ID	T 111	WWD	EP	UA	$\alpha$	NL
1.	(0,10,20)	5,00	21,45	10,7	0	0
2.	(0,9,9)	4,50	21,45	10,7	0	0
3.	(0,8,8)	4,00	21,45	10,7	0	0
4.	(0,7,7)	3,50	21,45	10,7	0	0
5.	(0,6,6)	3,00	21,45	10,7	0	0
6.	(0,5,5)	2,50	21,45	10,7	0	0
7.	(0,4,4)	2,00	21,45	10,7	0	0
8.	(0,3,3)	1,50	21,45	10,7	0	0
9.	(0,2,2)	1,00	21,45	10,7	0	0
10.	(0,1,1)	0,50	21,45	10,7	0	0
11.	(0,0,0)	0	21,45	10,7	0	0

Based on the above results, we can conclude that the change in parameter values (a, b, c) of only one learning outcome T111 has a significant effect on the alpha ( $\alpha$ ) values and thus directly influences the suggestion of the lesson proposed to Student 1 when assessing ICT competence in Computer Science Courses.

#### IV. BENEFIT AND LIMITATIONS OF THE STUDY

The upgrade of the intelligent system could enrich the system in a way that the assessment of ICT competencies of students is at a highly professional level and should not be related to certain teaching syllabus, geographical and linguistic area. In this way, the standardization of knowledge assessment in the IS at the world level could be carried out. The system could adapt to the conditions of the new environment and, on the basis of the established criteria, select the most compatible assessment of competencies for the set conditions.

Therefore, different teachers would offer different opinions about the assessment of students' competencies and the system would be adapted to new conditions. This IS solution in the assessment of students' competencies would partially eliminate the ability to manage the system with inadequate and under-educated teachers. In any case, the question of objectivity of teachers in the student competence assessment system would be solved.

One of the possible solutions of the system would be the ability to adapt the system to new educational paradigms. The assessment of students' competences would be tailored to the needs and principles of new educational paradigms.

IS is designed to take each part can be expanded and upgraded to a completely new system that is independent from any software environment, which is one of the most significant advantages of the system.

The limitation of the intelligent system is dependence on Competency-Based Education (CBE) and Outcome-Based Education (OBE).

The system is designed so that the controller structure that is connected in series or parallel corresponds to modularly structured courseware from CBE and OBE. However, that is the only thing which cannot be changed in the system to represent limits in the IS.

#### V. CONCLUSION

Designing an intelligent system for assessing student ICT competences has opened many questions and dilemmas that are important for the further direction of developing a quality assessment of students' knowledge by teachers.

Further development of the intelligent system should focus on assessing students' competence without the great influence of teachers, which in some cases is not sufficient to manage the system of assessment of student competencies. The research would be developed in the direction of automatically conducted parameter movements a, b, and c for the function of belonging to certain learning outcomes. In the future, the idea is to develop an IS that would have an application in assessing different types of student competencies for different coursewares.

Role of ICT competency assessment has crucial importance to education systems. The formation of an IS based on the assessment of ICT competencies for CSS enables permanent student improvement and personalization of the process of correct assessment of students' competencies. Designing the IS defined a long-term and efficient way of assessing ICT competencies of students in CSS.

#### REFERENCES

- [1] Sleeman, D., & Brown, J. S. 1982. Introduction: Intelligent Tutoring Systems. Intelligent Tutoring Systems, D. Sleeman, J. S. Brown, Ed. Academic Press, 1982, pp. 1-11.
- [2] Murray, T. 1999. Authoring Intelligent Tutoring Systems: An Analysis of the State of the Art. *International Journal of Artificial Intelligence in Education* (1999), 10, pp. 98-129.
- [3] Yurdakul IK, Odabasi HF, Kilicer K, Coklar AN, Birinci G, Kurt AA. The development, validity and reliability of TPACK-deep: A technological pedagogical content knowledge scale. *Comput Educ.* 2012;58(3):964–77.
- [4] Eryilmaz M, Simsek N. The Evaluation of Students' Academic Achievements in Adaptive Environments. *Egitim Ve Bilim.* 2014;39(173).
- [5] Foltin M, Fodrek P, Blaho M, Murgaš J. Open Source Technologies in Education. In 2011. p. 131–5.
- [6] Elfaki AO, Alhawiti KM, AlMurtadha YM, Abdalla OA, Elshiekh AA. Rule-based recommendation for supporting student learning-pathway selection. *INTERNATIONAL JOURNAL OF EDUCATION AND INFORMATION TECHNOLOGIES.* 2015;9:81–94.
- [7] Collis B, Moonen J. Flexibility in higher Education: Revisiting expectations. *Rev Comun.* 2010;19(37):15–25.
- [8] Montrieux H, Vangestel S, Raes A, Matthys P, Schellens T. Blending Face-to-Face Higher Education with Web-Based Lectures: Comparing Different Didactical Application Scenarios. *Educ Techno Soc.* 2015;18(1):170–82.
- [9] Blaho M, Foltin M, Fodrek P, Murgas J. Student's Diversity Problem in Programming Courses, in the book 8th WSEAS International Conference. on ENGINEERING. Corfu Greece. 2011;127–31.
- [10] Zoltán Balogh, Milan Turčan, Martin Magdin. Use of Petri Nets for Evaluation Modeling of the Student Transition Through the Web Environment. *INTERNATIONAL JOURNAL OF EDUCATION AND INFORMATION TECHNOLOGIES.* 2015;9:29–35.
- [11] European Commission. (2010). COMMUNICATION FROM THE COMMISSION EUROPE 2020A strategy for smart, sustainable and inclusive growth. Brussels, 3.3.2010.
- [12] EACEA/Eurydice, 2009b. National Testing of Pupils in Europe: Objectives, Organisation and Use of Results. Brussels: EACEA P9 Eurydice.
- [13] ECDL Foundation. (1997 - 2015). European Computer Driving Licence Foundation. Преузето јануар 18, 2015 са ECDL: <http://www.ecdl.com/>
- [14] Mandic D., Jotanovic G., Jausevac G., Vladusic LJ. i Mandic A., (2014), Informatics Teaching Methodology in Improving Informatics Students Competencies, *Advances in Electrical Engineering and Educational Technologies, Proceedings of 2nd International Conference on Systems, Control and Informatics (SCI 2014)*, Included in ISI-Web of Science, ISBN 978-1-61804-254-5, Athens, Greece, November 2014.
- [15] Komisija/EACEA/Eurydice, E. (2012). Developing Key Competences at School in Europe: Challenges and Opportunities for Policy. Luksemburg: Ured za publikacije Evropske unije.
- [16] Mandic, D; Ristic, M., (2011), Evropski standardi informatičkih kompetencija, Čigoja, Beograd, str. 355.
- [17] UNESCO, ICT Competency Standards For Teachers, by the United Nations Educational, Scientific and Cultural Organization, United Kingdom, Published in 2008.
- [18] Zadeh, L. A. (1965). Fuzzy sets. *Information and control*, 8(3), 338-353.
- [19] Abdullah, L., Amin, W. A. A. W. M., Mansor, N. R., Noor, N. M. M., & Amirudin, N. A. (2020). First Year Students' Perceptions of their Computer-Related Skills: A Preliminary Study.
- [20] Tapscott, D. (1998). *Growing up digital* (Vol. 302). New York: McGraw-Hill.
- [21] Lajis, A., Baharudin, S. A., Ab Kadir, D., Ralim, N. M., Nasir, H. M., & Aziz, N. A. (2018). A Review of Techniques in Automatic Programming Assessment for Practical Skill Test. *Journal of Telecommunication, Electronic and Computer Engineering (JTEC)*, 10(2-5), 109-113.
- [22] Mohayidin, Mohd Ghazali (2008). "Implementation of Outcome-Based Education in Universiti Putra Malaysia: A Focus on Students' Learning Outcomes". *International Education Studies.* 1(4). Retrieved 23 October 2014.